

Recommended P.C.B. Layout

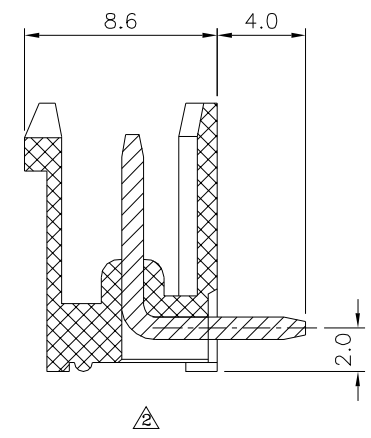
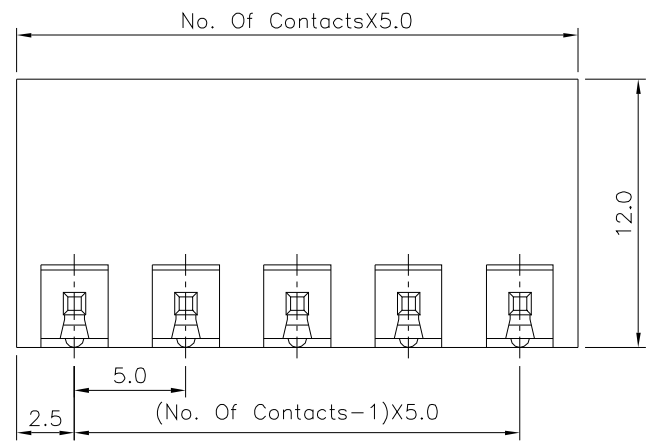
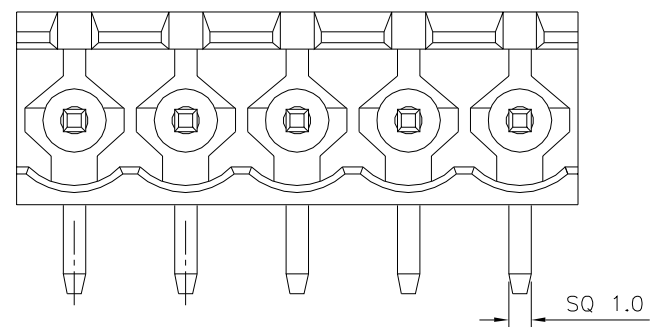

△△△△ SPECIFICATION
 Current Rating:16A
 Voltage Rating:300V AC
 Withstand Voltage:2500V AC/Minute
 Using Temperature Range:-40°C~+105°C
 Insulator:Polyamide+G.F.(UL94V-0),Green
 Solder Pin:Copper Alloy,Tin Plated
 RoHS Compliant

4UCON 元化興業股份有限公司
 4UCON TECHNOLOGY INC.

DRAWING No. 05333		APPROVED BY EMILY	
		CHECKED BY HZF	
		DRAWING BY HAO	
SCALE	NONE	REV.	A3

UNLESS OTHERWISE SPECIFIED TOLERANCES ARE			
	X.	±0.50	
	.X	±0.30	
	.XX	±0.20	
	X°	±1°	
NO.	REV.	REVISIONS	DATE
△3	A3	Modify Data	HZF 10/29/2024
△2	A2	Modify Data	HZF 03/07/2015
△1	A1	Modify Data	HZF 04/20/2011
△0	A0	NEW RELEASE	HZF 05/13/2009