

SPECIFICATION
 ⚠ Insulator:ABS(UL94HB)
 Screw,Nut&SR:Steel,Nickel Plated
 Packing:1 Set/Bag
 RoHS Compliant

Hood Insulator Color	Item No.
Chromate Plated	06895
Gray	16160
Black	21674

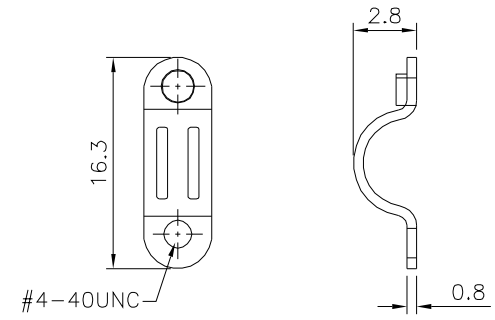
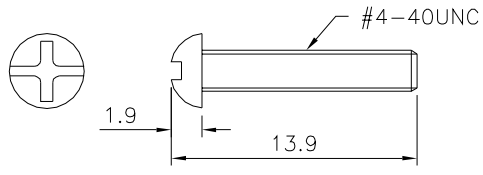
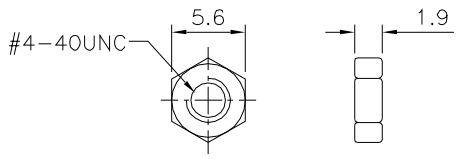
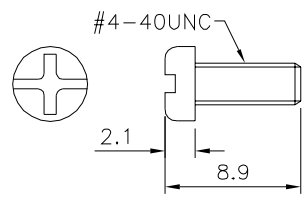
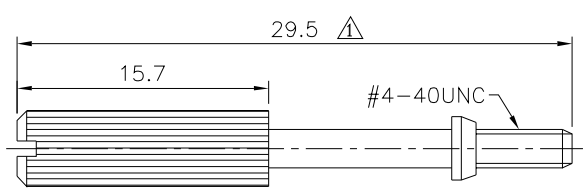
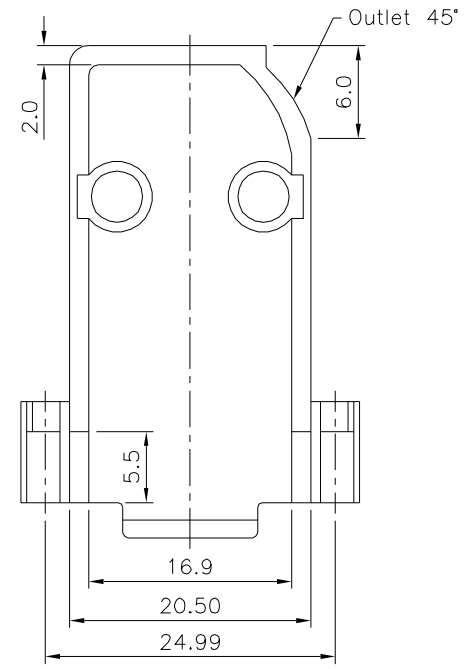
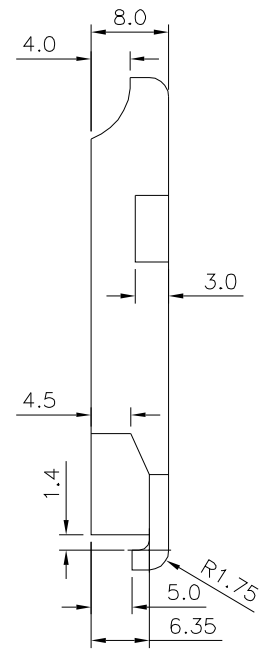
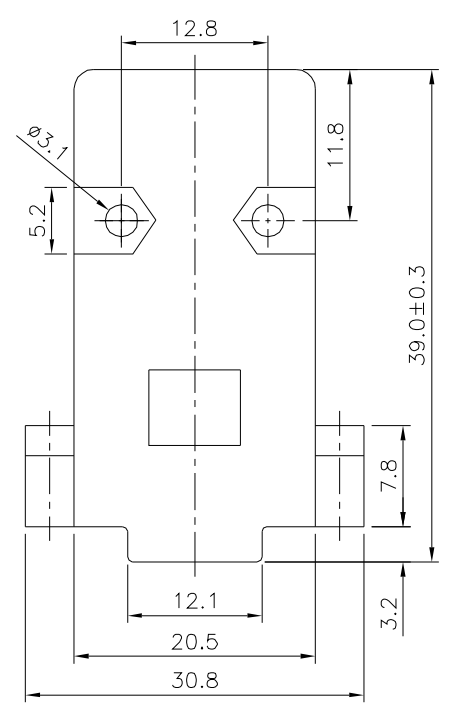

4U CON 元化興業股份有限公司
 4U CON TECHNOLOGY INC.

DRAWING No.		APPROVED BY		UNLESS OTHERWISE SPECIFIED TOLERANCES ARE .X ±0.38 .XX ±0.25 ANG.
06895		MEI		
		CHECKED BY		
		HZF		
		DRAWING BY		UNIT mm
		SONG		
SCALE	NONE	REV.	A2	NO. REV.

NO.	REV.	REVISIONS	CHK	DATE
2	A2	Modify Data	HZF	07/09/2014
1	A1	Modify Data	HZF	12/10/2008
0	A0	NEW RELEASE	HZF	02/07/2008