

- △△ SPECIFICATION**
- General Characteristics**  
1.0mm FPC XXP SMT 90° ZIF Bottom Contact
  - Material&Finish**  
Housing:PA9T(UL94V-0),Ivory  
Slider:PPS(UL94V-0),Black  
Terminal:Phosphor Bronze  
Tin Plated Over Nickel
  - Me:Brass,Tin Plated Over Nickel**
  - Electrical Characteristics**  
Operating Voltage:100V AC Max.  
Current Rating:0.5 Amp Max.  
Contact Resistance:30 Milliohms Max.  
Insulation Resistance:500 Megaohms Min.  
Dielectric Voltage:500V AC RMS
  - Environmental Characteristics**  
Operation Temperature:-40°C~+85°C  
Processing Temperature:260°C±5°C For 30s
  - RoHS Compliant**

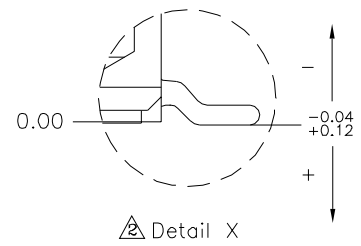
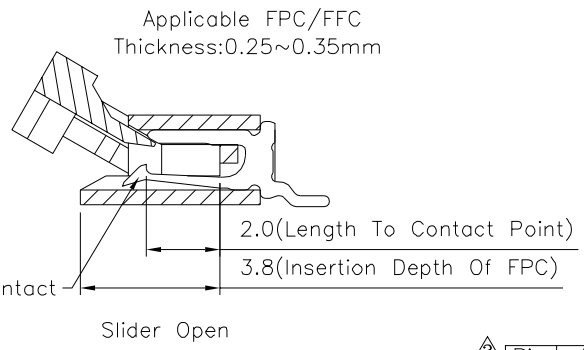
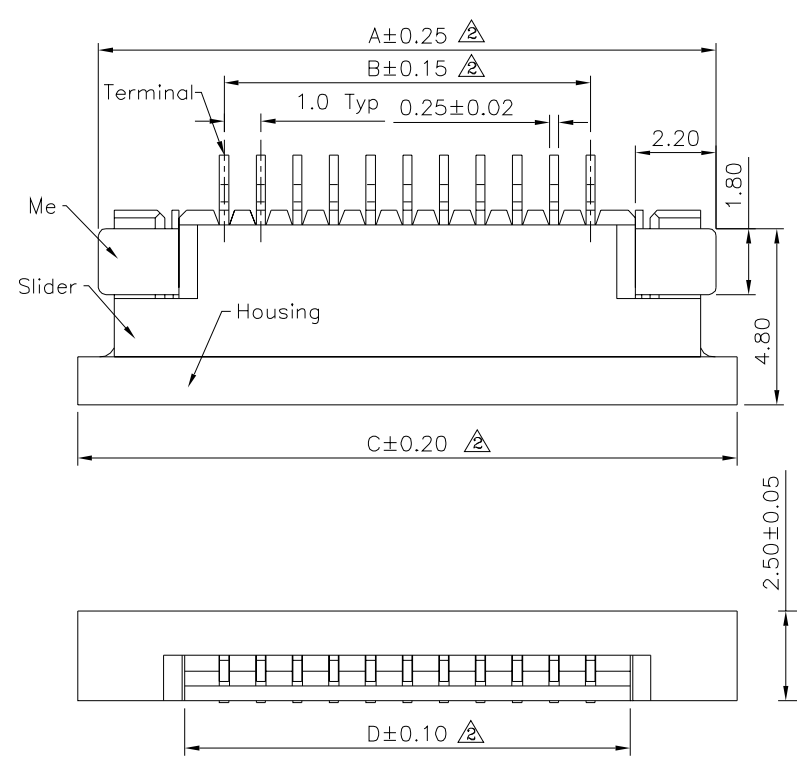

Pin	A	B	C	D	Pin	A	B	C	D
04	10.00	3.00	11.00	5.05	20	26.00	19.00	27.00	21.05
05	11.00	4.00	12.00	6.05	21	27.00	20.00	28.00	22.05
06	12.00	5.00	13.00	7.05	22	28.00	21.00	29.00	23.05
07	13.00	6.00	14.00	8.05	23	29.00	22.00	30.00	24.05
08	14.00	7.00	15.00	9.05	24	30.00	23.00	31.00	25.05
09	15.00	8.00	16.00	10.05	25	31.00	24.00	32.00	26.05
10	16.00	9.00	17.00	11.05	26	32.00	25.00	33.00	27.05
11	17.00	10.00	18.00	12.05	27	33.00	26.00	34.00	28.05
12	18.00	11.00	19.00	13.05	28	34.00	27.00	35.00	29.05
13	19.00	12.00	20.00	14.05	29	35.00	28.00	36.00	30.05
14	20.00	13.00	21.00	15.05	30	36.00	29.00	37.00	31.05
15	21.00	14.00	22.00	16.05	31	37.00	30.00	38.00	32.05
16	22.00	15.00	23.00	17.05	32	38.00	31.00	39.00	33.05
17	23.00	16.00	24.00	18.05	33	39.00	32.00	40.00	34.05
18	24.00	17.00	25.00	19.05	34	40.00	33.00	41.00	35.05
19	25.00	18.00	26.00	20.05					

**4UCON** 元化興業股份有限公司  
4UCON TECHNOLOGY INC.

DRAWING No. <b>07197</b>		APPROVED BY EMILY		UNLESS OTHERWISE SPECIFIED TOLERANCES ARE  .XX ±0.25
		CHECKED BY HZF		
		DRAWING BY GAO		
SCALE	NONE	REV.	A3	UNIT mm

NO.	REV.	REVISIONS	CHK	DATE
△A3		Modify Data	HZF	07/29/2013
△A2		Modify Data	HZF	06/17/2011
△A1		Modify Data	SHIN	01/09/2007
△A0		NEW RELEASE	HZF	05/11/2006