

**SPECIFICATIONS**

Current Rating: 3 Amp/Contact Max.  
 Contact Resistance: 4 Milliohms Max./Contact  
 Insulation Resistance: 1000 Megohms Min. At 100V  
 Operating Voltage: 60V AC/DC  
 Average Insertion Force With Steel Pin Of  $\phi 0.43\text{mm}$ : <50g  
 Average Withdrawal Force With Steel Pin Of  $\phi 0.43\text{mm}$ : >15g  
 Mechanical Life Cycle: 200 Min.  
 Operating Temperature:  $-40^{\circ}\text{C}$  To  $+105^{\circ}\text{C}$   
 Soldering Temperature:  $+260^{\circ}\text{C}$ , 10s Max.  
 Pin(Outer Sleeve): Brass, Machined CuZn38Pb2  
 Clip(Contact 6 Finger): Beryllium Copper, Heat Treated  
 Plating(Outer Sleeve): Tin Plated:  $2\mu\text{m}/80\text{u}''$  Ni,  $5\mu\text{m}/200\text{u}''$  Sn  
 Plating(Contact):  $2\mu\text{m}/80\text{u}''$  Ni, Gold Plated  
 Insulator: Glass Filled Thermoplastic Polyester, UL 94V-0, Black

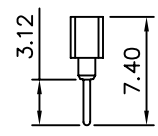
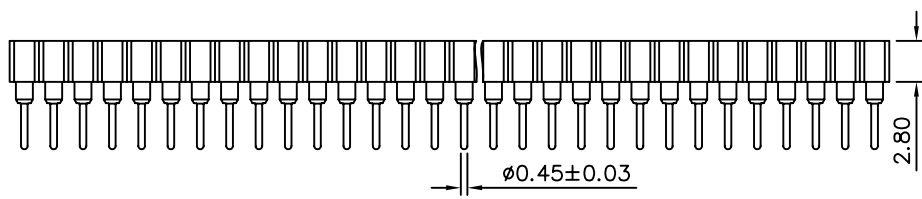
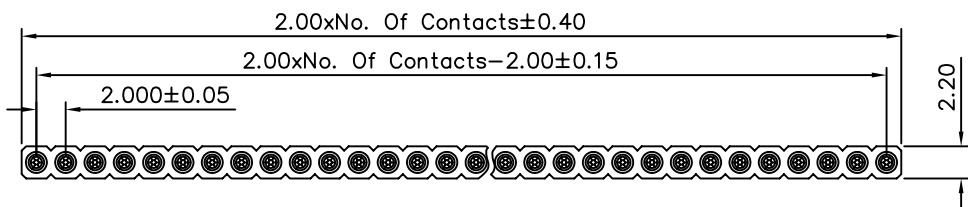
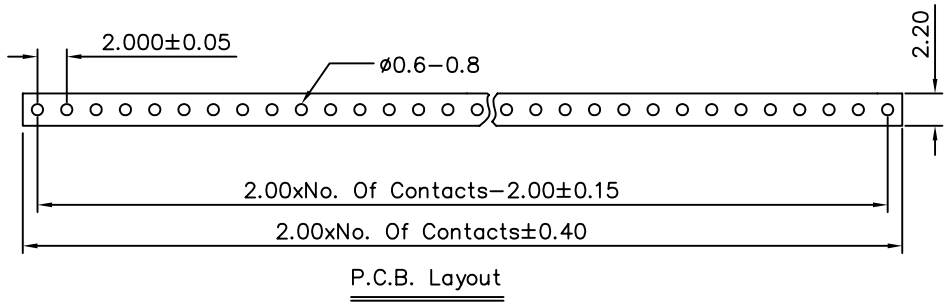

**4UCON** 元化興業股份有限公司  
 4UCON TECHNOLOGY INC.

DRAWING No.		APPROVED BY		UNLESS OTHERWISE SPECIFIED TOLERANCES ARE X. ±0.35 .X ±0.20 .XX ±0.15 .XXX ±0.05 ANG ±5°					
07686		MEI							
		CHECKED BY							
		BECKY							
		DRAWING BY							
		HZF							
SCALE	NONE	REV.	A0	UNIT	mm	NO. REV.	REVISIONS	CHK	DATE
						A0	NEW RELEASE	BECKY	11/04/2005