

△ SPECIFICATION

Current Rating:3A
 Voltage Rating:250V AC/RMS 60Hz
 Contact Resistance:20 Milliohms Max.
 At 1 Amp DC
 Insulation Resistance:1000 Megaohms
 Min. At 500V DC
 Dielectric Withstanding Voltage:
 1000V AC/RMS For 1 Minute
 Housing:PBT+G.F.(UL94V-0),Black
 Contact:Phosphor Bronze,Gold Flash On Contact Area,
 Tin Plated On Solder Tails,Over Nickel
 Shell:Steel,Tin Plated Over Copper
 Boarlock:Brass,Tin Plated
 RoHS Compliant

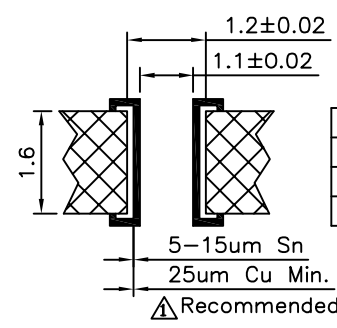
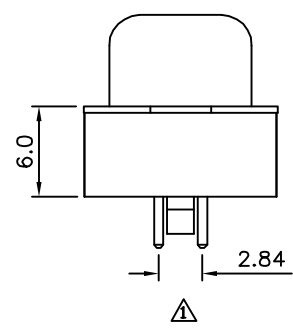
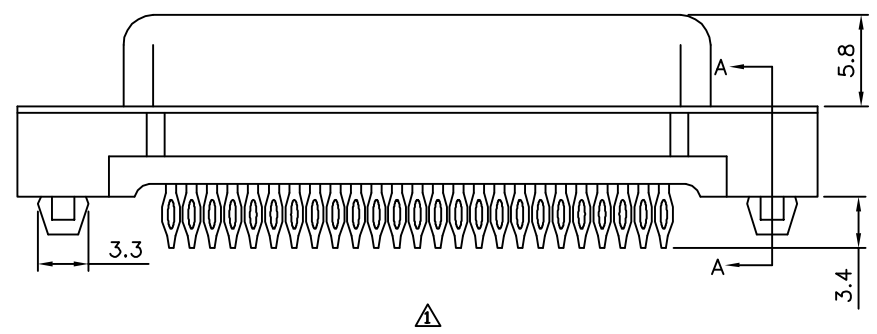
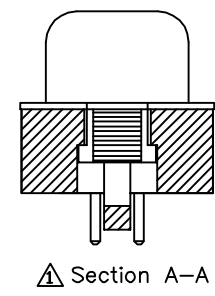
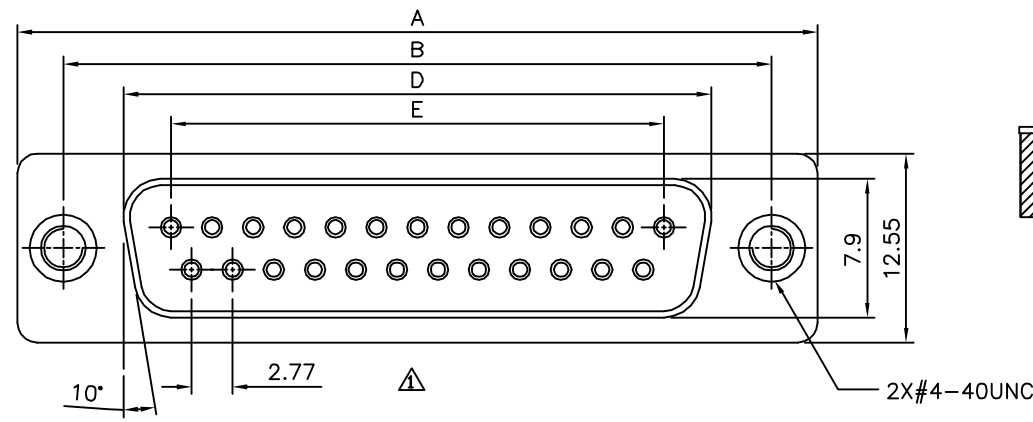

Drilled Hole	1.20±0.02mm
Finished Hole	1.10±0.02mm
Cu	Min 25um
Sn	5-15um

Pin	A	B	D	E
09	30.81	24.99	16.33	11.08
15	39.20	33.30	24.70	19.39
25	53.05	47.04	38.40	33.24
37	69.40	63.50	54.80	49.86

4UCON 元化興業股份有限公司
 4UCON TECHNOLOGY INC.

DRAWING No.		APPROVED BY		UNLESS OTHERWISE SPECIFIED TOLERANCES ARE △ X. ±0.38 X.' ±3" .X ±0.25 .X' ±1.0" .XX ±0.13
07936		EMILY		
		CHECKED BY		
		HZF		
		DRAWING BY		
		HAO		
SCALE	NONE	REV.	A1	UNIT
				mm

NO.	REV.	REVISIONS	CHK	DATE
△ A1		Modify Data	HZF	05/14/2015
△ A0		NEW RELEASE		