

SPECIFICATION
 Current Rating:1A AC/DC
 Voltage Rating:100V AC/DC
 Withstanding Voltage:500V AC/Minute
 Contact Resistance:20 Milliohms Max.
 Insulation Resistance:500 Megohms Min.
 Temperature Range:-25°C~+85°C
 Contact:Brass,Tin Plated
 Insulator:PA9T(UL94V-0)
 RoHS Compliant

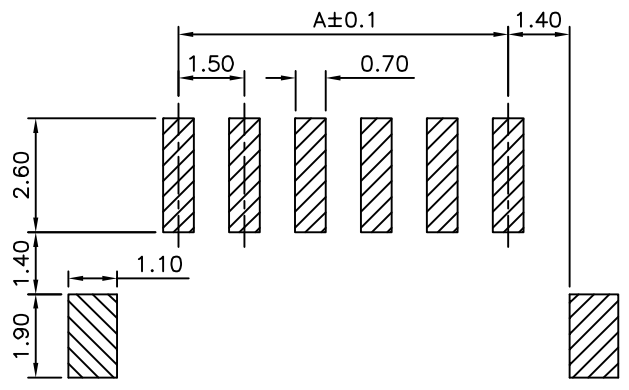

Recommended P.C.B. Layout

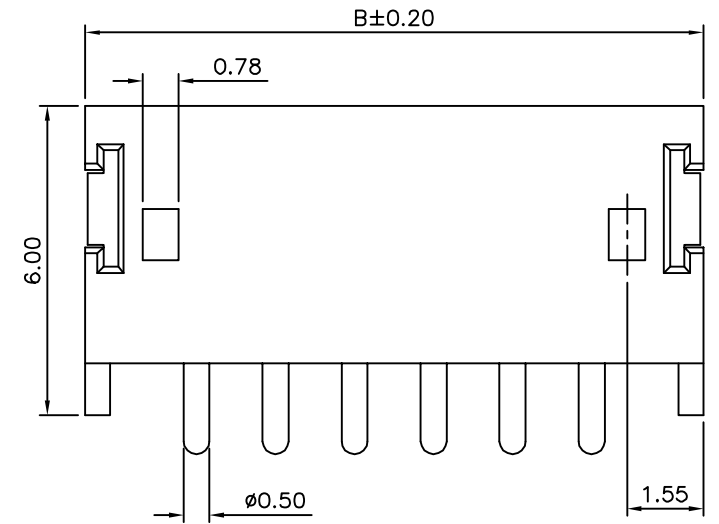
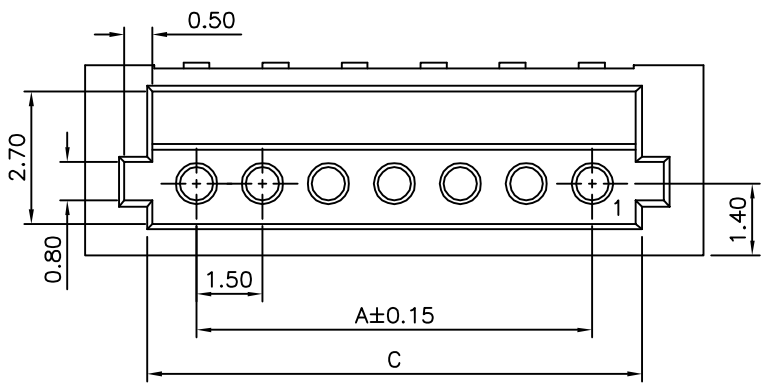
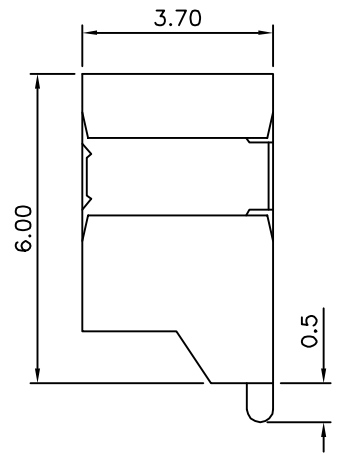

Pin	A	B	C
2	1.50	6.00	3.60
3	3.00	7.50	5.10
4	4.50	9.00	6.60
5	6.00	10.50	8.10
6	7.50	12.00	9.60
7	9.00	13.50	11.10
8	10.50	15.00	12.60
9	12.00	16.50	14.10
10	13.50	18.00	15.60
11	15.00	19.50	17.10
12	16.50	21.00	18.60
13	18.00	22.50	20.10

4UCON 元化興業股份有限公司
 4UCON TECHNOLOGY INC.

DRAWING No.		APPROVED BY		UNLESS OTHERWISE SPECIFIED TOLERANCES ARE .X ±0.3 .XX ±0.2 ANG.
08942		EMILY		
		CHECKED BY		
		HZF		
		DRAWING BY		
		SONG		
SCALE	NONE	REV.	A1	UNIT mm

NO.	REV.	REVISIONS	CHK	DATE
△A1		Modify Data	HZF	07/22/2013
△A0		NEW RELEASE	HZF	10/02/2009

SPECIFICATION
 Q'ty:1000 PCS/Reel
 RoHS Compliant

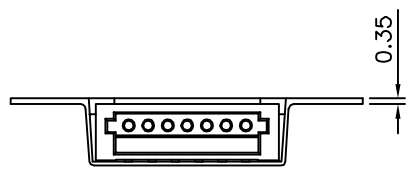
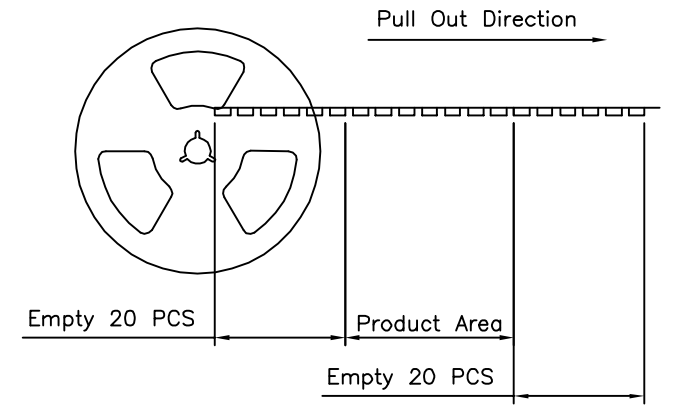
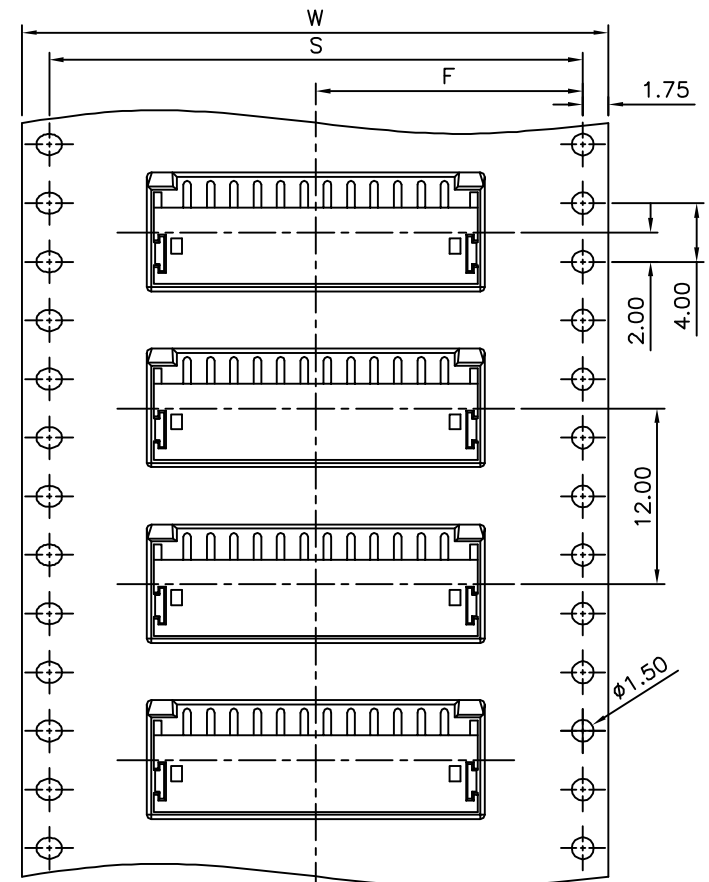
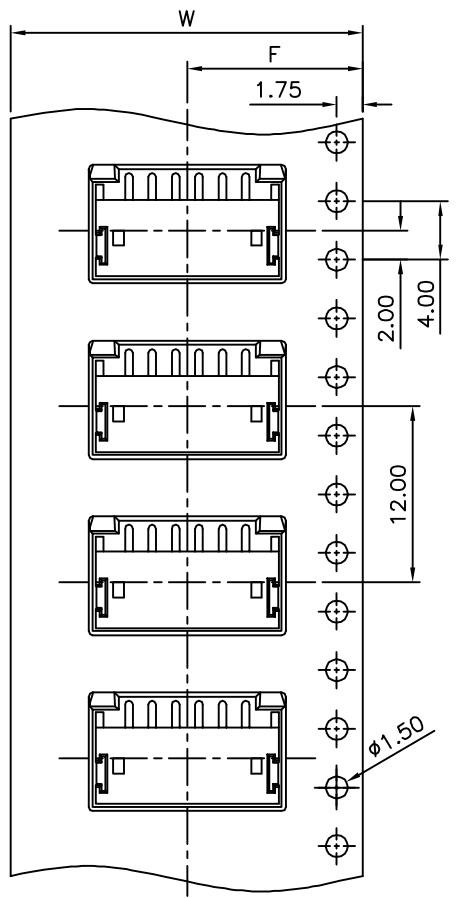

2~9 Pin

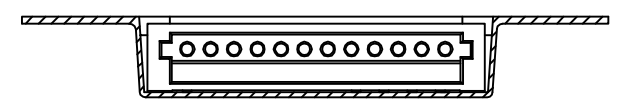

10~13 Pin

Pin	A	B	S
02	16	7.50	/
03	16	7.50	
04	16	7.50	
05	24	11.5	
06	24	11.5	
07	24	11.5	
08	24	11.5	
09	24	11.5	
10	32	14.2	
11	44	20.2	40.4
12	44	20.2	40.4
13	44	20.2	40.4

4UCON 元化興業股份有限公司
 4UCON TECHNOLOGY INC.

DRAWING No.		APPROVED BY		UNLESS OTHERWISE SPECIFIED TOLERANCES ARE .X ±0.25 .XX ±0.15 ANG.
08942		EMILY		
		CHECKED BY HZF		
		DRAWING BY SONG		UNIT mm
SCALE	NONE	REV.	A1	

NO.	REV.	REVISIONS	CHK	DATE
△A1		Modify Data	HZF	07/22/2013
△A0		NEW RELEASE	HZF	10/02/2009