

SPECIFICATION
 Current Rating:16A/Way Max.
 Voltage Rating:300V AC
 Contact Resistance:20 Milliohms Max.
 Withstanding Voltage:2500V AC/Minute
 Operation Temperature:-40°C~+105°C
 Wire Range:12~26 AWG
 Torque:5.0 Kgf.cm/M3
 Insulator Body:Polyamide(UL94V-0),Green
 Contact:Copper Alloy,Nickel Plated
 Wire Guard:Copper Alloy,Tin Plated
 Screw:Steel,Galvanized With Cr3+ Plated
 RoHS Compliant

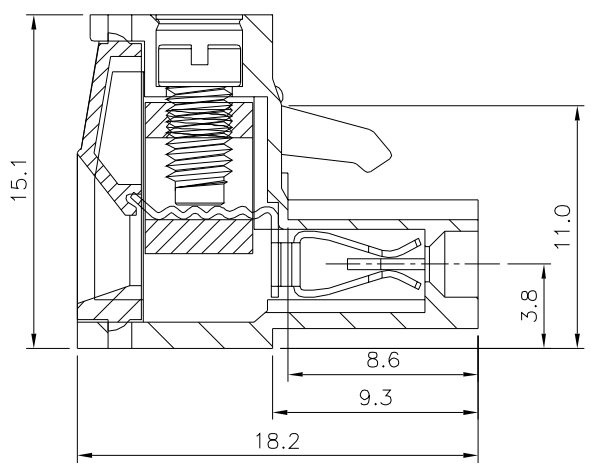
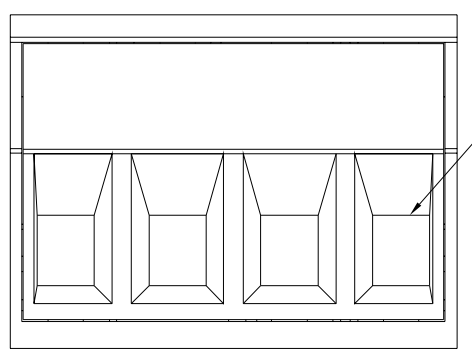
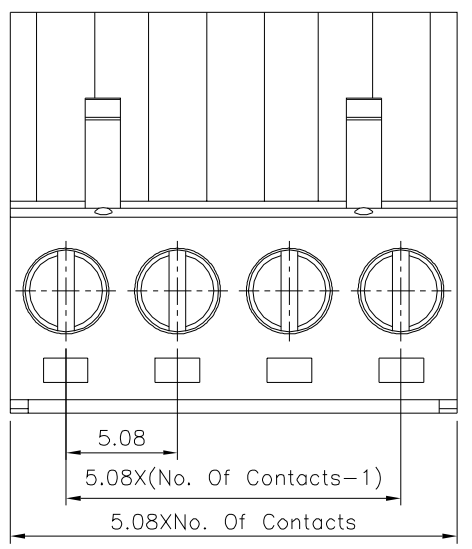

4UCON 元化興業股份有限公司
 4UCON TECHNOLOGY INC.

DRAWING No.		APPROVED BY		UNLESS OTHERWISE SPECIFIED TOLERANCES ARE X. ±0.50 .X ±0.30 .XX ±0.20 ANG. ±1°
09183		Jason Wu		
		CHECKED BY		
		Leo Han		
DRAWING BY		Michelle Lee		
SCALE	NONE	REV.	B0	UNIT mm

NO.	REV.	REVISIONS	CHK	DATE
△ B0		NEW RELEASE	HZF	07/25/2024