

Recommended PCB Layout

SPECIFICATIONS

Current Rating: 2A AC/DC
 Voltage Rating: 250V AV/DC
 Insulation: Nylon UL94V-2
 Contact: Copper Alloy 0.64mm Square Pin
 Tin-Plating Or Gold Flash
 Poles: 2-28

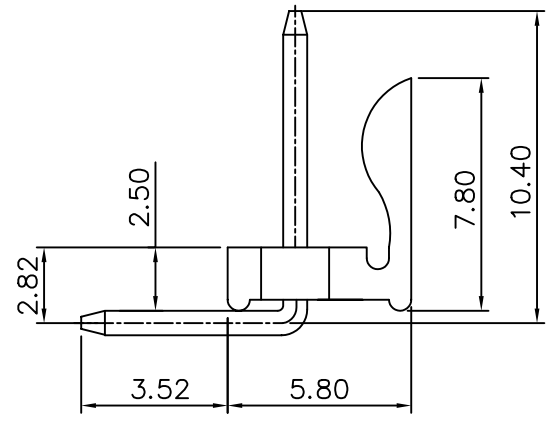
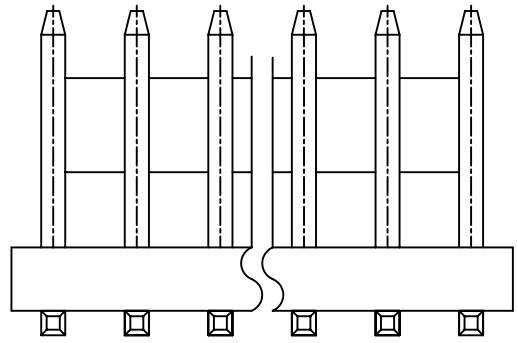

Circuits	A	B
2	2.54	5.08
3	5.08	7.62
4	7.62	10.16
5	10.16	12.70
6	12.70	15.24
7	15.24	17.78
8	17.78	20.32
9	20.32	22.86
10	22.86	25.40
11	25.40	27.94
12	27.94	30.48
13	30.48	33.02
14	33.02	35.56
15	35.56	38.10
16	38.10	40.64
17	40.64	43.18
18	43.18	45.72
19	45.72	48.26
20	48.26	50.80
21	50.80	53.34
22	53.34	55.88
23	55.88	58.42
24	58.42	60.96
25	60.96	63.50
26	63.50	66.04
27	66.04	68.58
28	68.58	71.12

4UCON 元化興業股份有限公司
 4UCON TECHNOLOGY INC.

DRAWING No. 09484

APPROVED BY MEI
 CHECKED BY RAN
 DRAWING BY HZF

UNLESS OTHERWISE SPECIFIED
 TOLERANCES ARE
 .X ±0.38
 .XX ±0.25
 AWG.

SCALE NONE REV. A UNIT mm

AREA	REVISIONS	CHK	DATE