

**△ SPECIFICATION**

Current Rating:1 Amp  
 Voltage Rating:250V AC RMS  
 Dielectric Withstanding Voltage:500V AC RMS 60Hz  
 For 1 Minute  
 Contact Resistance:30 Milliohms Max. At 1 Amp DC  
 Insulation Resistance:1000 Megohms Min.  
 At 500V DC  
 Temperature Range:-55°C~+85°C  
 Insulator:PA66+G.F.  
 Contact:Brass  
 Gold Flash On Contact Area,Tin Plated  
 On Solder Tails,Over Nickel  
 RoHS Compliant

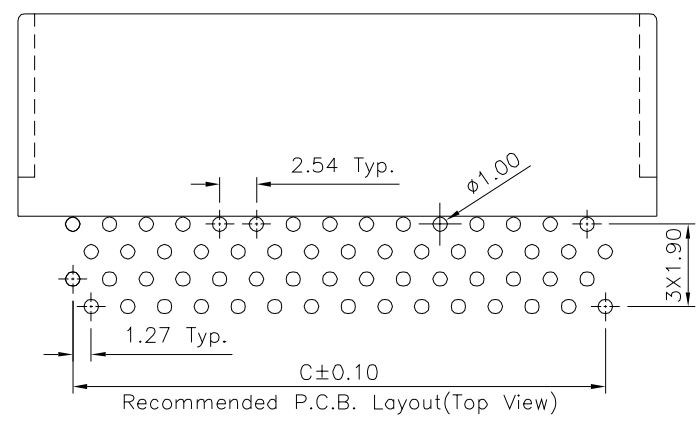
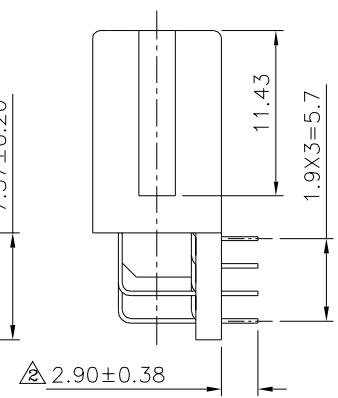
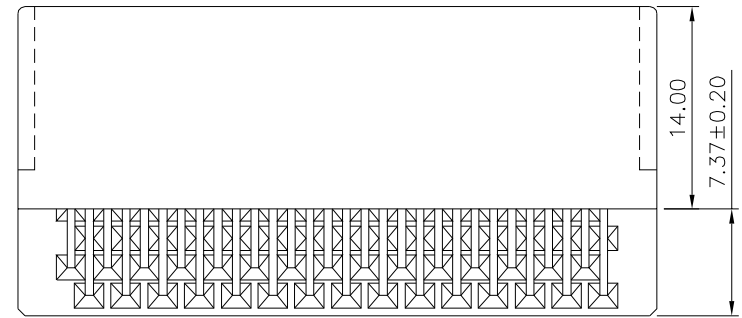
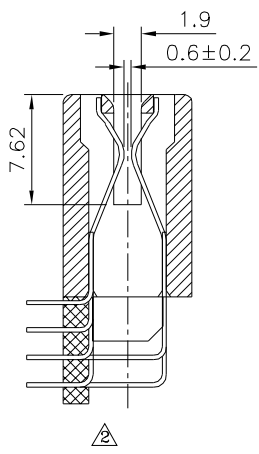
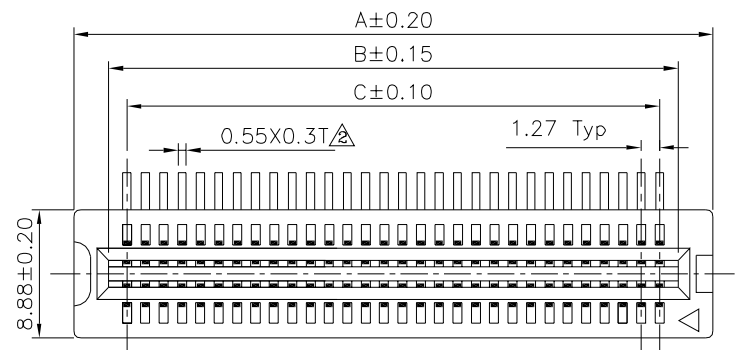

△△△

Pin	A	B	C	Pin	A	B	C
04	8.64	3.81	1.27	32	26.42	21.59	19.05
06	9.91	5.08	2.54	34	27.69	22.86	20.32
08	11.18	6.35	3.81	36	28.96	24.13	21.59
*10	12.45	7.62	5.08	38	30.23	25.40	22.86
12	13.72	8.89	6.35	42	32.77	27.94	25.40
14	14.99	10.16	7.62	44	34.04	29.21	26.67
16	16.26	11.43	8.89	46	35.31	30.48	27.94
18	17.53	12.70	10.16	48	36.58	31.75	29.21
*20	18.80	13.97	11.43	52	39.12	34.29	31.75
*22	20.07	15.24	12.70	54	40.39	35.56	33.02
*24	21.34	16.51	13.97	56	41.66	36.83	34.29
26	22.61	17.78	15.24	58	42.93	38.10	35.56
28	23.88	19.05	16.51	100	69.60	64.77	62.23
*30	25.15	20.32	17.78	*120	82.30	77.47	74.93

The Mark Of "\*" Are Tooled Ready

**4UCON** 元化興業股份有限公司  
 4UCON TECHNOLOGY INC.

DRAWING No. 10156  
 SCALE NONE

APPROVED BY MEI  
 CHECKED BY HZF  
 DRAWING BY CYP  
 REV. B4

UNLESS OTHERWISE SPECIFIED TOLERANCES ARE  
 X. ±0.20  
 .X ±0.15  
 .XX ±0.10  
 .XXX ±0.05

NO.	REV.	REVISIONS	CHK	DATE
△ B4		Modify Data	HZF	09/23/2022
△ B3		Modify Data	HZF	01/30/2019
△ B2		Modify Data	HZF	01/17/2019
△ B1		Modify Data	HZF	11/07/2015
△ B0		NEW RELEASE	HZF	09/08/2014

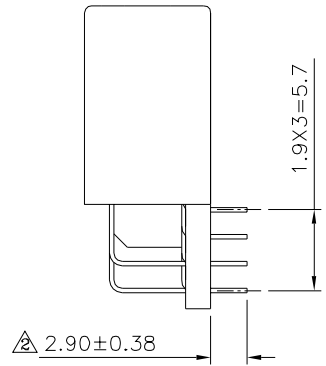
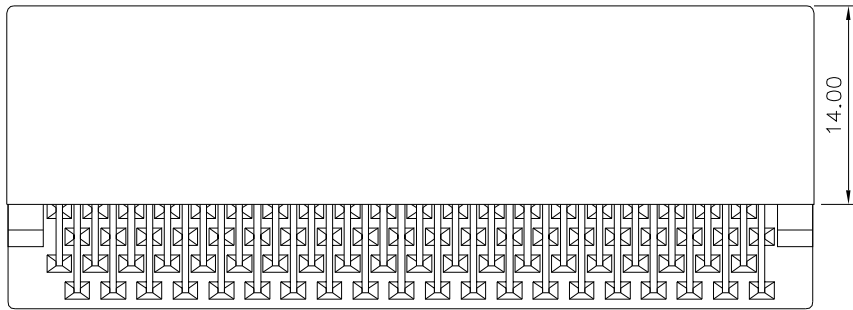
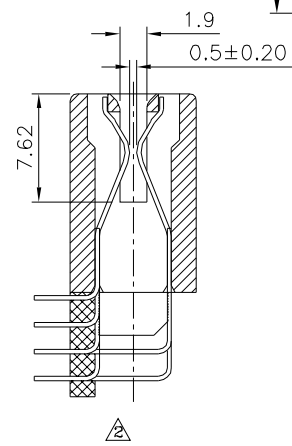
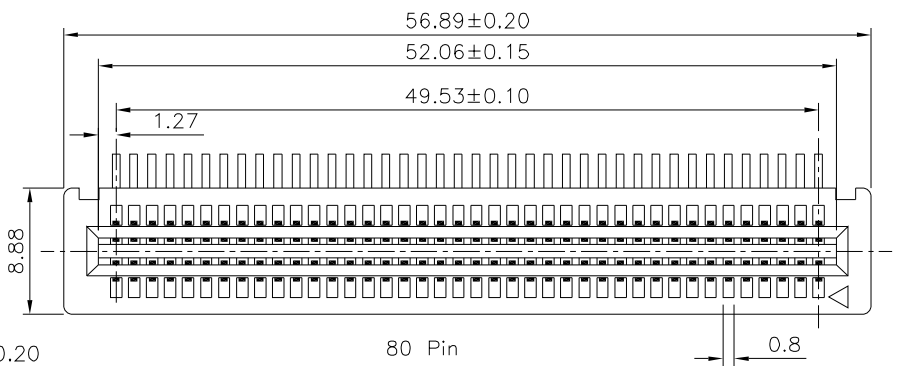
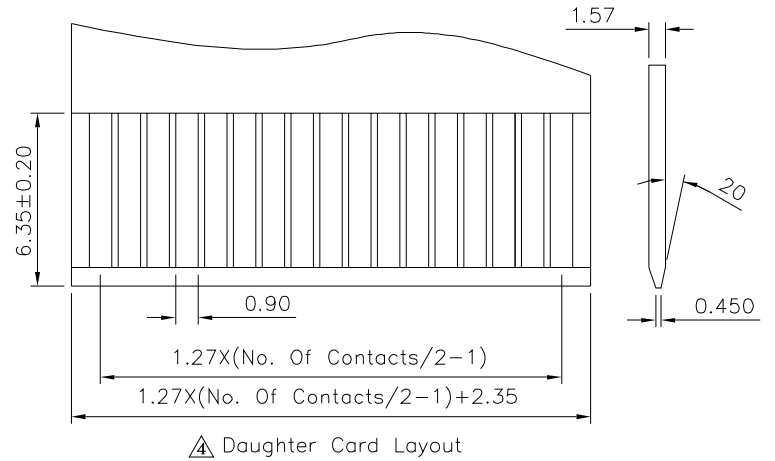
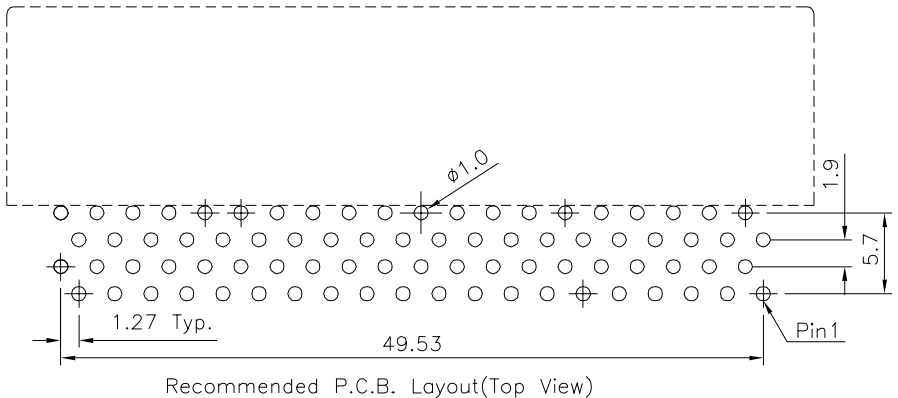

**4UCON** 元化興業股份有限公司  
4UCON TECHNOLOGY INC.

DRAWING No.		APPROVED BY		UNLESS OTHERWISE SPECIFIED TOLERANCES ARE 0~10 ±0.20 10~30 ±0.30 30~100 ±0.40 100~300 ±0.50 ANG. ±0.5°
10156		MEI		
		CHECKED BY		
HZF		CYP		
SCALE	NONE	REV.	B4	UNIT mm

△4	B4	Modify Data	HZF	09/23/2022
△3	B3	Modify Data	HZF	01/30/2019
△2	B2	Modify Data	HZF	01/17/2019
△1	B1	Modify Data	HZF	11/07/2015
△0	B0	NEW RELEASE	HZF	09/08/2014
NO.	REV.	REVISIONS	CHK	DATE

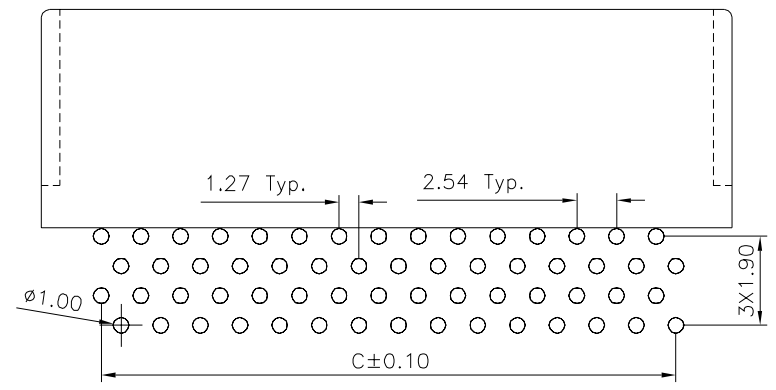
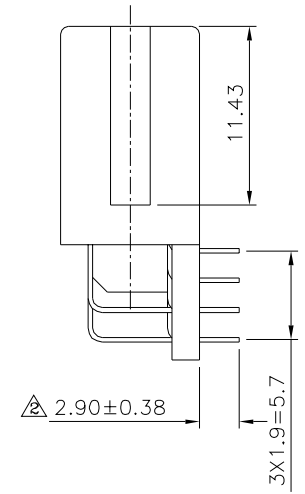
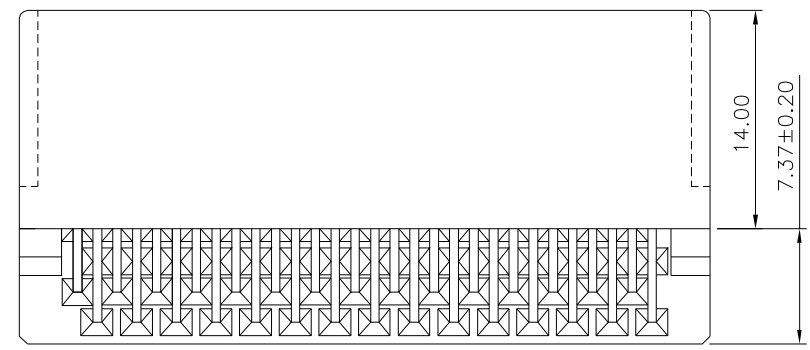
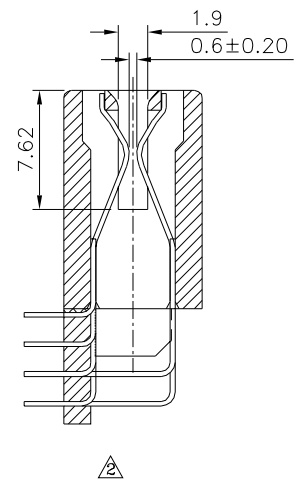
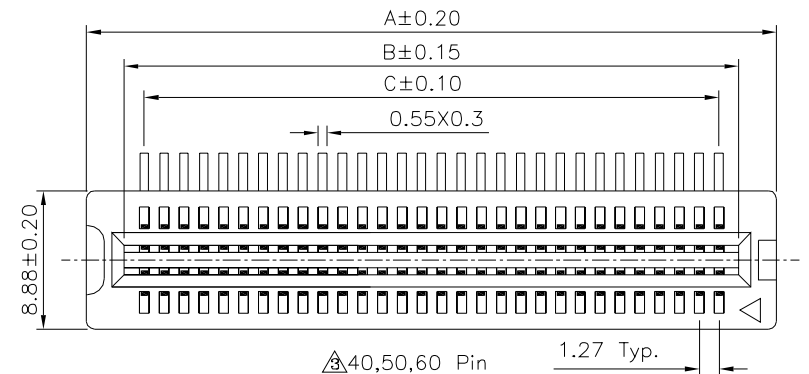

Pin	A	B	C
40	31.50	26.67	24.13
50	37.85	33.02	30.48
60	44.20	39.37	36.83

**4UCON** 元化興業股份有限公司  
4UCON TECHNOLOGY INC.

DRAWING No. 10156

APPROVED BY MEI  
CHECKED BY HZF  
DRAWING BY CYP

UNLESS OTHERWISE SPECIFIED TOLERANCES ARE  
.X ±0.20  
.XX ±0.15  
.XX ±0.10  
.XXX ±0.05

NO.	REV.	REVISIONS	CHK	DATE
B4		Modify Data	HZF	09/23/2022
B3		Modify Data	HZF	01/30/2019
B2		Modify Data	HZF	01/17/2019
B1		Modify Data	HZF	11/07/2015
B0		NEW RELEASE	HZF	09/08/2014

SCALE NONE REV. B4 UNIT mm

NO. REV. REVISIONS CHK DATE