

SPECIFICATIONS
 Current Rating: 7A Max.
 Voltage Rating: 250V AC, DC
 Withstanding Voltage: 1000V AC/Minute
 Insulation Resistance: 1000Megohms Min.
 Temperature Range: -40°C To +105°C
 (Including Temp.Rise)
 Insulator: Nylon 66, UL94V-2

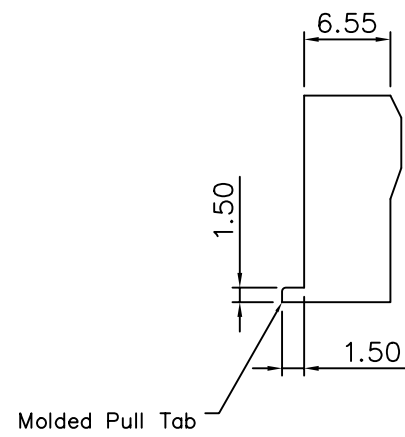
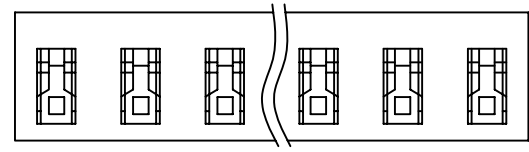
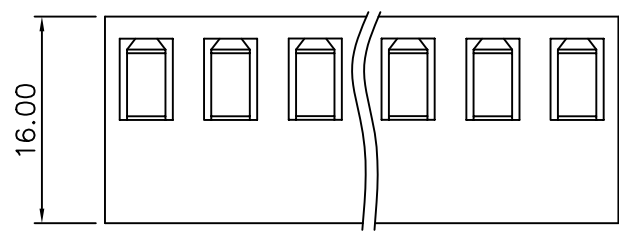
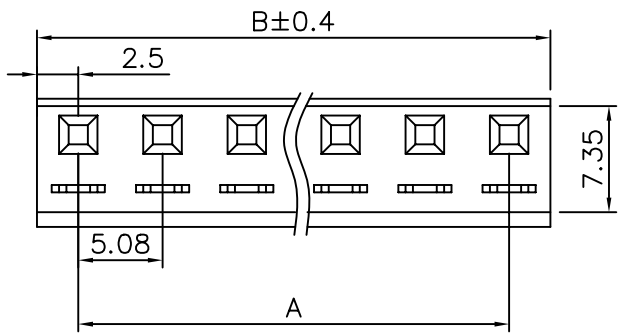

Circuits	Dim A	Dim B
2	5.08	10.33
3	10.16	15.41
4	15.24	20.49
5	20.32	25.57
6	25.40	30.65
7	30.48	35.73
8	35.56	40.81
9	40.64	45.89
10	45.72	50.97
11	50.80	56.05
12	55.88	61.13

4UCON 元化興業股份有限公司
 4UCON TECHNOLOGY INC.

DRAWING No.
 10488

APPROVED BY MEI
 CHECKED BY BECKY
 DRAWING BY HZF

UNLESS OTHERWISE SPECIFIED TOLERANCES ARE
 .X ±0.40
 .XX ±0.25
 .XXX ±0.08

SCALE NONE

REV. A0

UNIT mm

NO. REV.

NEW RELEASE REVISIONS

MEI CHK DATE