

Recommended P.C.B. Layout

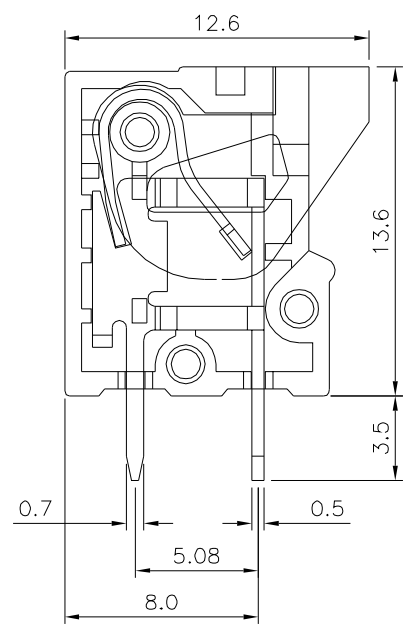
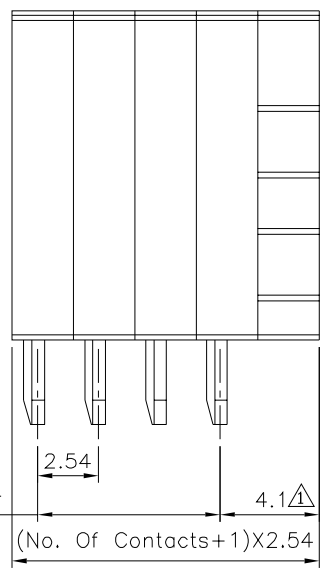

△△△ SPECIFICATION
 Current Rating:2 Amp/Way Max.
 Voltage Rating:150V AC
 Withstanding Voltage:2000V AC(1 Minute)
 Test Time=60s/PCS
 Contact Resistance:20 Milliohms Max.
 Wire Range:20~26 AWG
 Operation Temperature:-40°C~+105°C
 Test Temperature:250°C 5 Seconds Max.
 Wire Guard:Stainless Steel
 Surface Of Solder Tails:Copper Alloy,Tin Plated
△4 Insulator Body(Housing):Polyamide+G.F.(UL94V-0),Green RoHS Compliant
 * 02~20P Available

4UCON 元化興業股份有限公司
 4UCON TECHNOLOGY INC.

DRAWING No. △△△		APPROVED BY EMILY		UNLESS OTHERWISE SPECIFIED TOLERANCES ARE X. ±0.50 .X ±0.30 .XX ±0.20 ANG. ±1°	△4 A4	Modify Data	HZF	06/18/2020
11382		CHECKED BY HZF			△3 A3	Modify Data	HZF	05/12/2015
		DRAWING BY HAO			△2 A2	Modify Data	HZF	09/10/2013
SCALE	NONE	REV.	A4	UNIT mm	△1 A1	Modify Data	HZF	01/06/2012
					△0 A0	NEW RELEASE	HZF	05/23/2009
					NO.REV.	REVISIONS	CHK	DATE