

SPECIFICATION

Current Rating:1 Amp
 Voltage Rating:250V AC RMS
 Dielectric Withstanding Voltage:500V AC RMS 60Hz
 For 1 Minute
 Insulation Resistance:1000 Megaohms Min. At 500V DC
 Contact Resistance:30 Milliohms Max.
 Retention Force:460 Grams Min. Per Contact
 Insertion Force:230 Grams Max. Per Contact Pair
 Withdrawal Force:15 Grams Min. Per Contact Pair
 Temperature Range:-55°C~+85°C
 Insulator:PA66+G.F. Black
 Contact:Brass,Gold Flash On Contact Area,
 Tin Plated On Solder Tails,Over Nickel
 RoHS Compliant

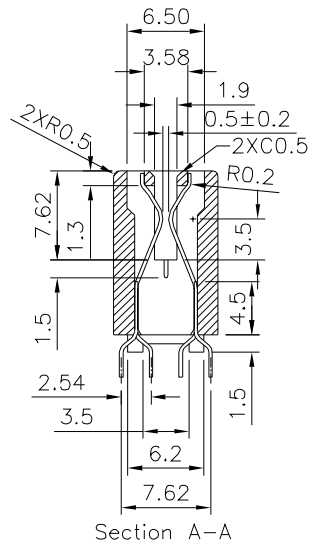
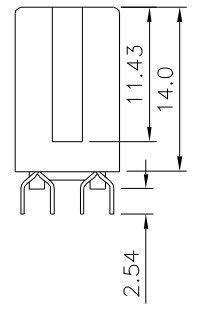
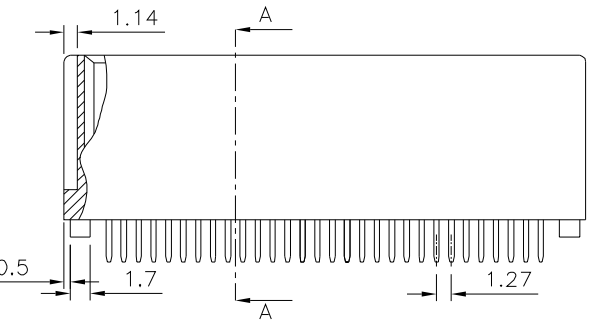
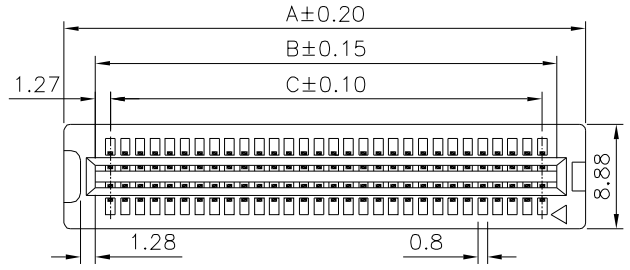
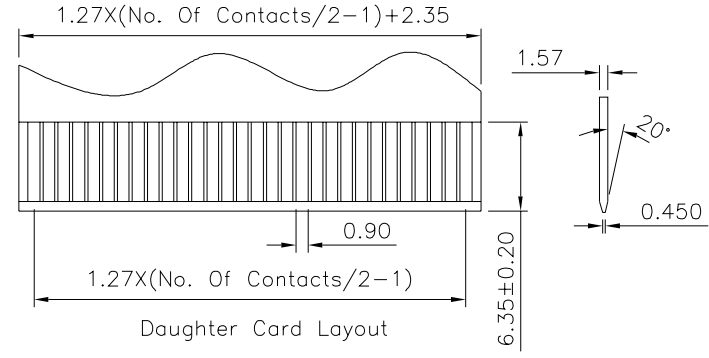
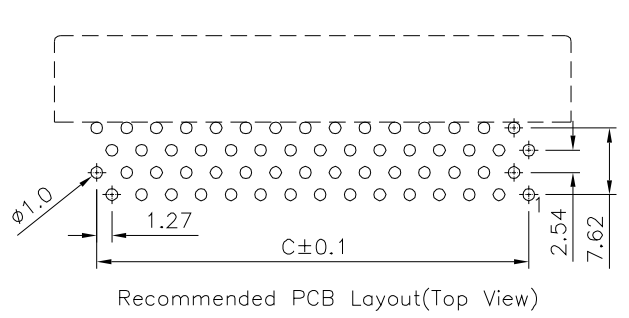

Pin	A	B	C	Pin	A	B	C
04	8.64	3.81	1.27	*42	32.77	27.94	25.40
06	9.91	5.08	2.54	*44	34.04	29.21	26.67
08	11.18	6.35	3.81	*46	35.31	30.48	27.94
10	12.45	7.62	5.08	48	36.58	31.75	29.21
12	13.72	8.89	6.35	50	37.85	33.02	30.48
14	14.99	10.16	7.62	52	39.12	34.29	31.75
16	16.26	11.43	8.89	*54	40.39	35.56	33.02
*18	17.53	12.70	10.16	*56	41.66	36.83	34.29
20	18.80	13.97	11.43	*58	42.93	38.10	35.56
22	20.07	15.24	12.70	60	44.20	39.37	36.83
24	21.34	16.51	13.97	68	49.28	44.45	41.91
26	22.61	17.78	15.24	70	50.55	45.72	43.18
*28	23.88	19.05	16.51	80	56.90	52.07	49.53
30	25.15	20.32	17.78	100	69.60	64.77	62.23
32	26.42	21.59	19.05	120	82.30	77.47	74.93
*34	27.69	22.86	20.32	124	84.84	80.01	77.47
36	28.96	24.13	21.59	*140	95.00	90.17	87.63
*38	30.23	25.40	22.86	*182	121.67	116.84	114.30
40	31.50	26.67	24.13				

Note:The Mark Of "*" Aren't Toolled

4UCON 元化興業股份有限公司
 4UCON TECHNOLOGY INC.

DRAWING No.		APPROVED BY		UNLESS OTHERWISE SPECIFIED TOLERANCES ARE 0~10 ±0.2 10~30 ±0.3 30~100 ±0.4 100~300 ±0.5 300~ ±0.8 ANG. ±0.5
12355		MEI		
		HZF		
		DRAWING BY		
		CYP		
SCALE	NONE	REV.	CO	UNIT mm

△ CO	NEW RELEASE	HZF	12/15/2022
NO. REV.	REVISIONS	CHK	DATE