

2P To 6P With Wedge,Above  
7P Without Wedge(Including 7P)

**SPECIFICATION**

Voltage Rating:300V AC  
 Current Rating:12 Amps/Way Max.  
 Contact Resistance:20 Milliohms Max.  
 Withstanding Voltage:2500V AC(1 Minute) Test  
 Time=60 Sec/1 PCS  
 Wire Range:16~24 AWG  
 Torque:2.5 Kgf.cm/M2  
 Operation Temperature:-40°C~+105°C  
 Soldering Reliability:  
 Test Temperature=250°C±10°C/5 Seconds Max.  
 Contact(Metal Housing):Copper Alloy,Nickel Plated  
 Terminal Screw:Steel,Galvanized With Cr3+ Plated  
 Wire Guard:Copper Alloy,Tin Plated  
 Insulator Body(Housing):Polyamide(UL94V-0),Green  
 RoHS Compliant

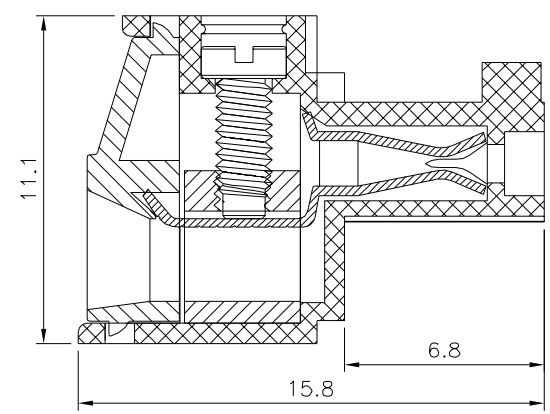
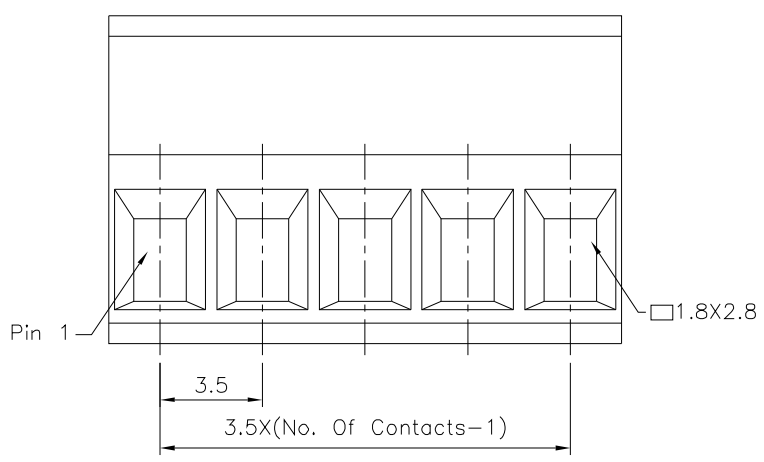

**4UCON** 元化興業股份有限公司  
4UCON TECHNOLOGY INC.

DRAWING No.		APPROVED BY		UNLESS OTHERWISE SPECIFIED TOLERANCES ARE X. ±0.50 .X ±0.30 .XX ±0.20 ANG. ±1°
13762		MEI		
		CHECKED BY HZF		
DRAWING BY		CYP		
SCALE	NONE	REV.	B0	UNIT mm

NO.	REV.	REVISIONS	CHK	DATE
△ B0		NEW RELEASE	HZF	10/04/2018