

Recommended P.C.B. Layout

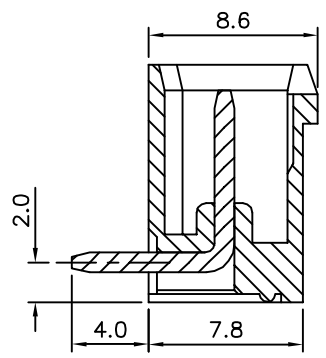
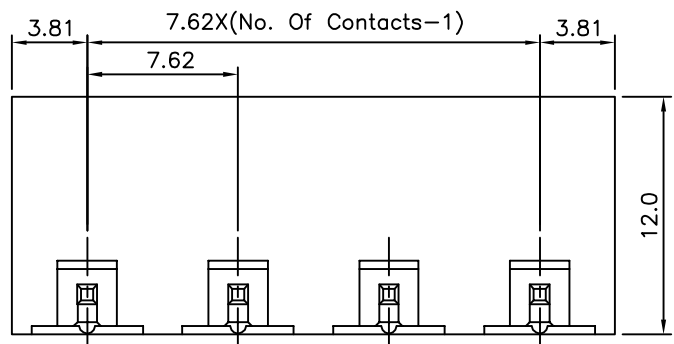

△SPECIFICATION

Current Rating:16A
 Voltage Rating:300V AC
 Withstand Voltage:2500V AC For 1 Minute
 Using Temperature Range:-40°C~+105°C
 Soldering Temperature:+250°C,5s Max.
 Insulator Body:Polyamide+G.F.(UL94V-0),Green
 Solder Pin:Copper Alloy,Tin Plated
 RoHS Compliant

4UCON 元化興業股份有限公司
 4UCON TECHNOLOGY INC.

DRAWING No.		APPROVED BY		UNLESS OTHERWISE SPECIFIED TOLERANCES ARE .X ±0.30 .XX ±0.15 .XXX ±0.05 ANG. ±1°
13845		EMILY		
		CHECKED BY		
		HZF		
		DRAWING BY		
		GAO		
SCALE	NONE	REV.	A1	UNIT
				mm

NO.	REV.	REVISIONS	CHK	DATE
△A1		Modify Spec.	HZF	03/13/2013
△A0		NEW RELEASE	HZF	03/10/2010