

SPECIFICATION
 Current Rating:10A
 Voltage Rating:250V AC
 Insulation Resistance:500 Megohms
 At DC 500V
 Withstanding Voltage:AC 1500V(1 Minute)
 Using Temperature Range:-40°C To +105°C
 Soldering Temperature:250°C,5 Seconds Max.
 Solder Pin:Copper Alloy,Tin Plated
 Insulator Body(Housing):Polyamide
 Glass Filled(UL94V-0),Green
 RoHS Compliant

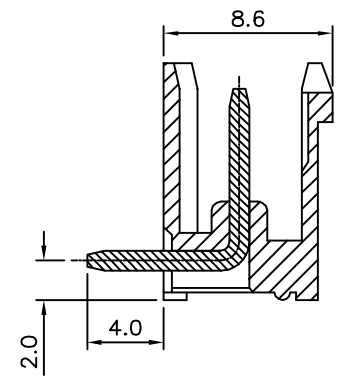
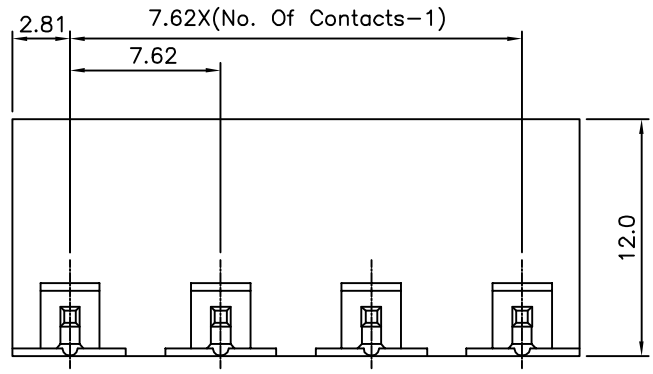
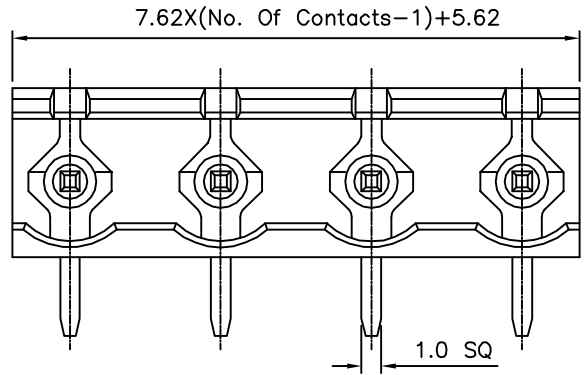
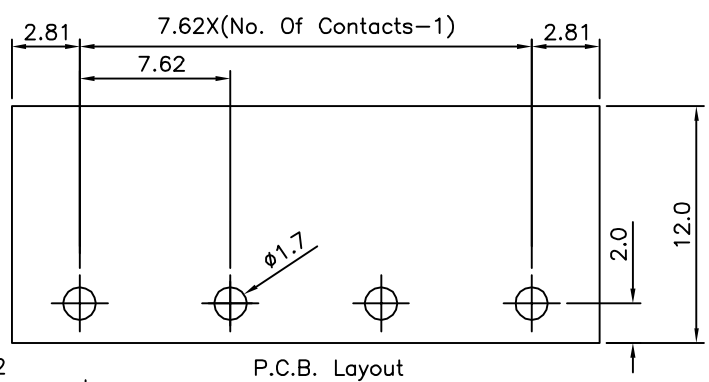

4UCON 元化興業股份有限公司
 4UCON TECHNOLOGY INC.

DRAWING No.		APPROVED BY		UNLESS OTHERWISE SPECIFIED TOLERANCES ARE X. ±0.30 .X ±0.15 .XX ±0.05 ANG. ±1°
13902		MEI		
		CHECKED BY		
		HZF		
		DRAWING BY		
		XYH		
SCALE	NONE	REV.	A0	UNIT
				mm

NO.	REV.	REVISIONS	CHK	DATE
△ A0		NEW RELEASE	HZF	03/10/2010