

Recommended P.C.B. Layout

△ SPECIFICATION
 △ Current:1A
 Withstanding Voltage:1000V AC Minute
 Contact Resistance:20 Milliohms Max.
 Insulation Resistance:5000 Megaohms Min.
 Operation Temperature:-55°C~+105°C
 Housing:PA6T(UL94V-0),Black
 Contact:Brass,Gold Flash Over Nickel
 △ No. Of Contacts:06~100 Contacts
 RoHS Compliant

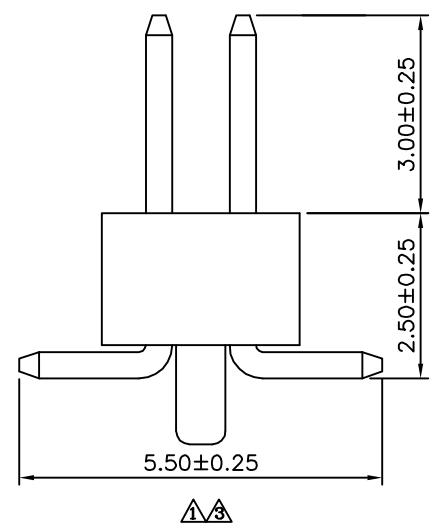
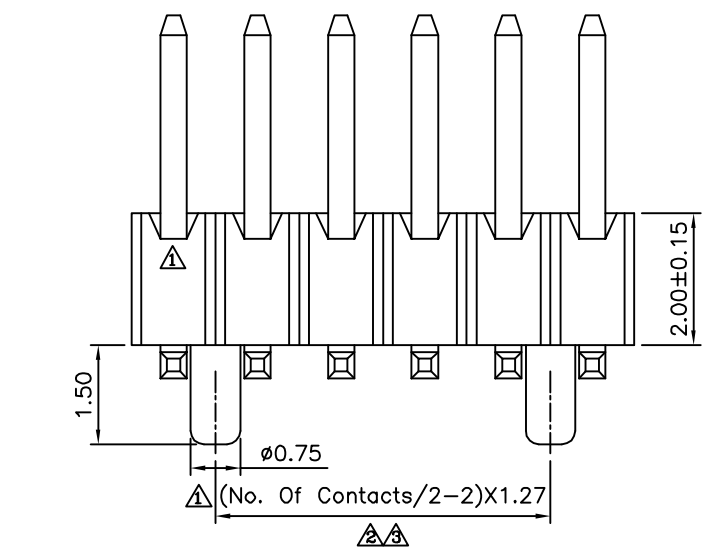

4UCON 元化興業股份有限公司
 4UCON TECHNOLOGY INC.

DRAWING No.		APPROVED BY		UNLESS OTHERWISE SPECIFIED TOLERANCES ARE .X ±0.38 .XX ±0.25 ANG. ±5°
14020		EMILY		
		CHECKED BY HZF		
		DRAWING BY YBL		
SCALE	NONE	REV.	A3	UNIT mm

NO.	REV.	REVISIONS	CHK	DATE
△ A3		Modify Data	HZF	11/29/2013
△ A2		Modify Data	HZF	01/03/2011
△ A1		Modify Data	HZF	07/02/2009
△ A0		NEW RELEASE	SHIN	08/14/2006