

Specification

1. General Characteristics :

- . Contact Principle : Friction Technology
- . Mounting System : SMT
- . Durability : 10,000 Cycles Min.

2. Material

- . Data Contacts Material : Phosphor Bronze
- △. Data Contacts Plating : Gold Over Nickel
- . Insulation Material : Thermoplastic UL 94V-0

3. Electrical Characteristics

- △. Contact Resistance : 50 Milliohms Max.,
- . Insulator Resistance : >1000 Megohms/500V DC

4. Solderability

- . Wave : Not Applicable
- . Vapor Phase : 215°C, 30 Sec. Max.
- . IR Reflow : 260°C, 15 Sec. Max.
- . Manual Soldering : 360°C, 3 Sec. Max.

5. Environmental Characteristics

- . Operating Temperature : -40°C ~ +85°C
- . Operating Humidity : 10% ~ 95% RH
- . Storage Temperature : -40°C ~ +85°C
- . Storage Humidity : 10% ~ 95% RH
- RoHS Compliant

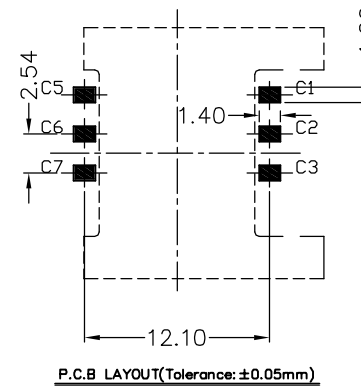

4UCON 元化興業股份有限公司
4UCON TECHNOLOGY INC.

DRAWING No.

15662

APPROVED BY

VIVIAN

CHECKED BY

LYS

DRAWING BY

QXQ

UNLESS OTHERWISE SPECIFIED TOLERANCES ARE

.X ± 0.38

.XX ± 0.25

ANG. $\pm 1^\circ$

UNIT mm

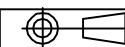

NO.

A1

Marked △ Were Modified

QXQ

01/30/2013



A0

NEW RELEASE

LYS

07/12/2009

NO.

REV.

REVISIONS

CHK

DATE

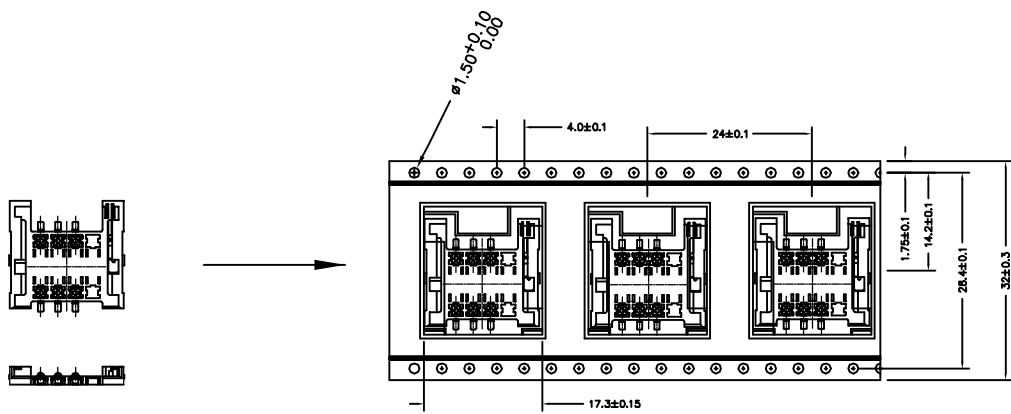

SPECIFICATIONS:

Reel Size: 330*36.5 mm
 QTY: 625Pcs/Reel
 RoHS Compliant

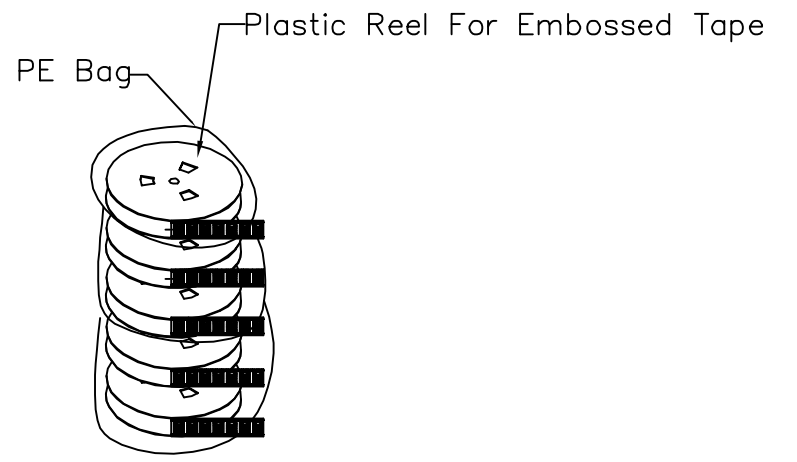
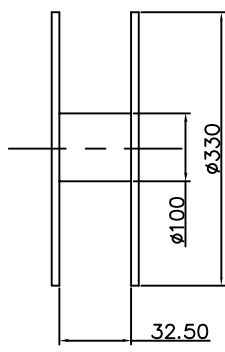
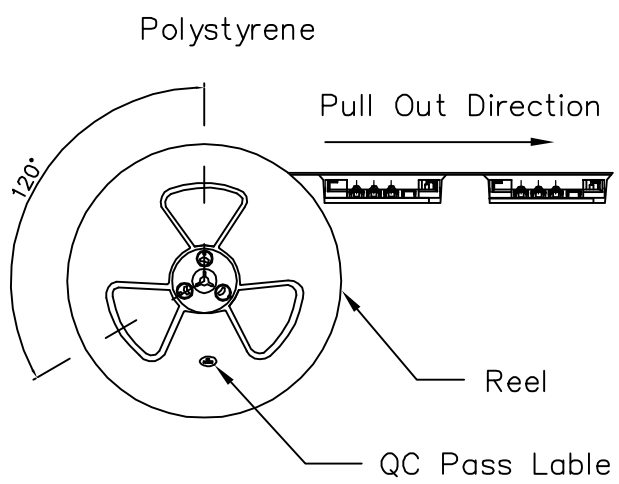
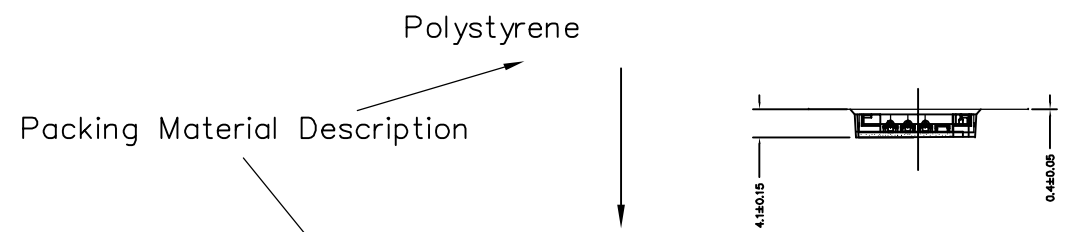

4UCON 元化興業股份有限公司
 4UCON TECHNOLOGY INC.

| | | | | |
|-------------|------|-------------|----|--|
| DRAWING No. | | APPROVED BY | | UNLESS OTHERWISE SPECIFIED TOLERANCES ARE .X ±0.20 .XX ±0.10 ANG. ±1° |
| 15662 | | VIVIAN | | |
| | | CHECKED BY | | |
| | | LYS | | |
| | | DRAWING BY | | |
| | | QXQ | | |
| SCALE | NONE | REV. | A1 | UNIT |
| | | | | mm |

| | | | | |
|-----|------|------------------------|-----|------------|
| NO. | REV. | REVISIONS | CHK | DATE |
| △ | A1 | Marked △ Were Modified | QXQ | 01/30/2013 |
| △ | A0 | NEW RELEASE | QXQ | 07/12/2010 |