

**SPECIFICATIONS :**

Impedance : 75 Ohms  
 Voltage Rating : 500V RMS  
 Frequency Range : 0-4 GHZ  
 Interface Per Mil-c-39012C  
 For RG-174 Cable

Body : Zinc Alloy , Nickel Plating  
 Pin : Brass, Gold Plating  
 Dielectric : Delrin  
 Washer : Brass, Nickel Plating  
 Ferrule : Brass, Nickel Plating  
 Spring : SK-5  
 Gasket : SI Rubber

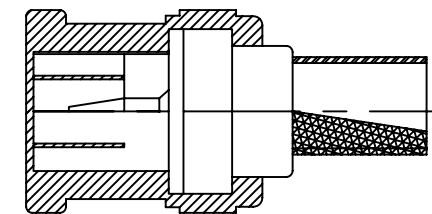
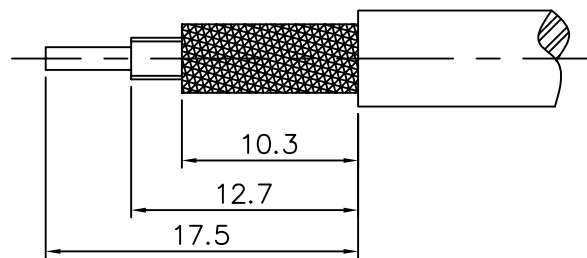
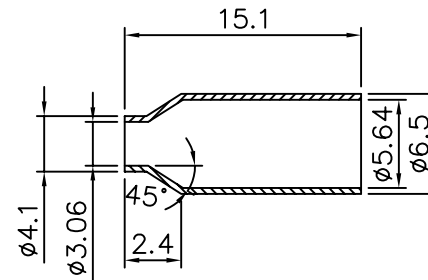
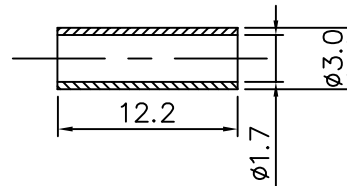
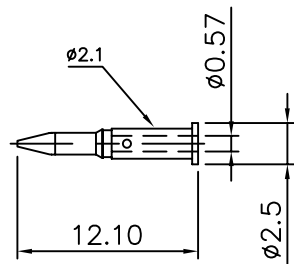
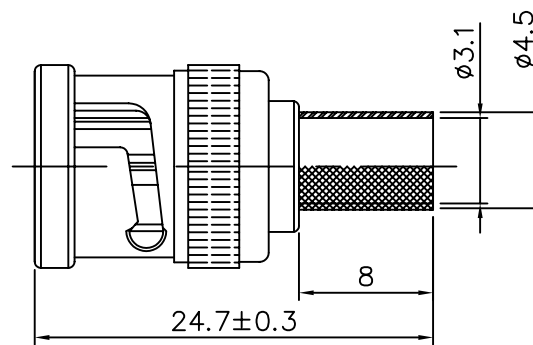
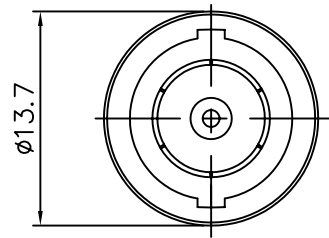

**4UCON** 元化興業股份有限公司  
 4UCON TECHNOLOGY INC.

DRAWING No.  
 15879

APPROVED BY MEI  
 CHECKED BY RAN  
 DRAWING BY HZF

UNLESS OTHERWISE SPECIFIED TOLERANCES ARE  
 X. ±0.5  
 .X ±0.3  
 .XX ±0.2

SCALE NONE

REV. A

UNIT mm



NO.	REV.	DESCRIPTION	CHK	DATE
△ A		NEW RELEASE	RAN	
		REVISIONS	CHK	DATE