

PCB Layout
(Bottom View)

Part No.	Ring Color		
	A	B	C
18118	Yellow	White	Red
18119	Yellow	Red	White
18120	Green	Blue	Red

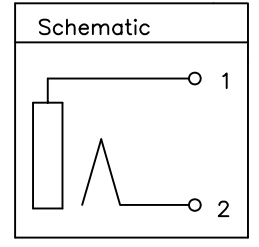
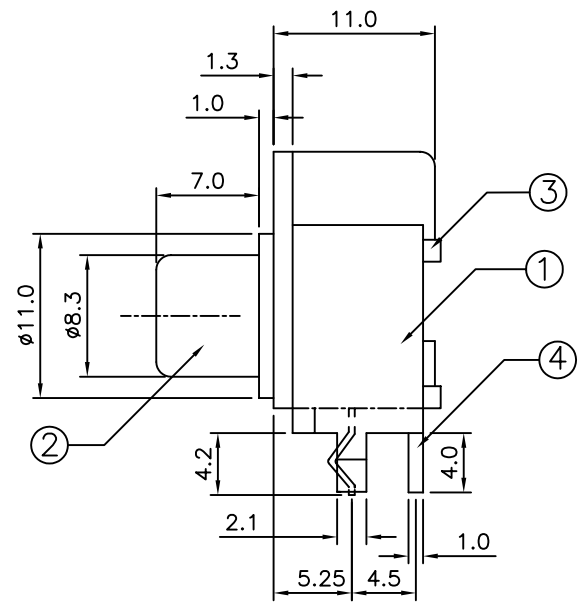
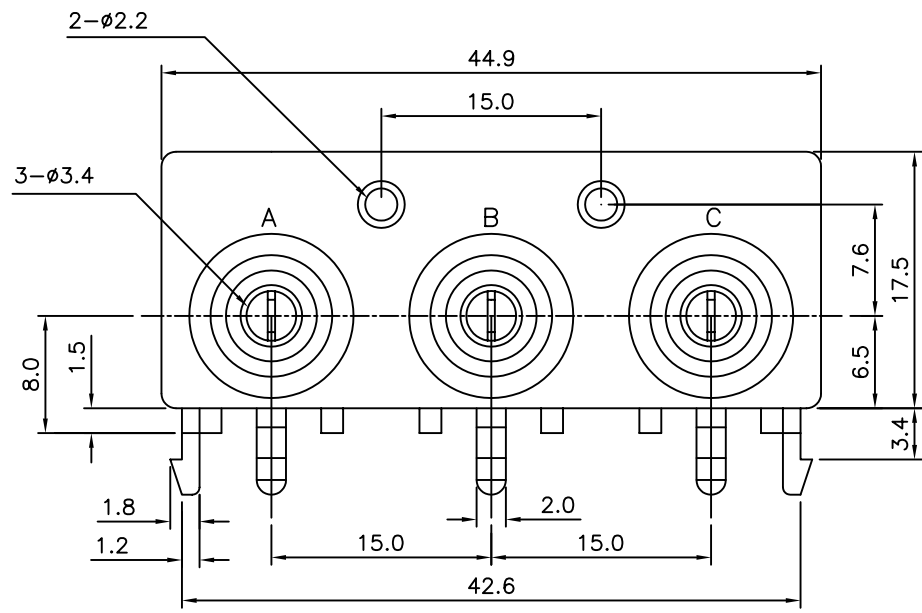

NO.	Name	Material	Finish	Q'TY
1	Assem. Housing	ABS	Black	1
2	Barrel	Brass,t=0.4	Nickel Plated	3
3	Jack Housing	P.B.T.		3
4	Contact Terminal	Brass,t=0.5	Tin Plated	3

4UCON 元化興業股份有限公司
4UCON TECHNOLOGY INC.

DRAWING No.		APPROVED BY		UNLESS OTHERWISE SPECIFIED TOLERANCES ARE .X ±0.3 .XX ±0.3 ANG.
18118		MEI		
		CHECKED BY		
		HZF		
		DRAWING BY		UNIT mm
		PEGA		
SCALE	NONE	REV.	A0	NO. REV.

AO	NEW RELEASE	HZF	09/29/2006
NO. REV.	REVISIONS	CHK	DATE