

SPECIFICATION

Current Rating:1 Amp
 Dielectric Withstanding Voltage:AC 1000V For 1 Minute
 Insulation Resistance:1000 Megaohms Min. At DC 500V
 Contact Resistance:30 Milliohms Max. At DC 100mA
 Operation Temperature:-65°C~+125°C
 Housing:LCP(UL94V-0)
 Contact:Brass
 Gold Plated 10u" On Contact Area,Tin
 Plated On Solder Tails,Over Nickel
 RoHS Compliant

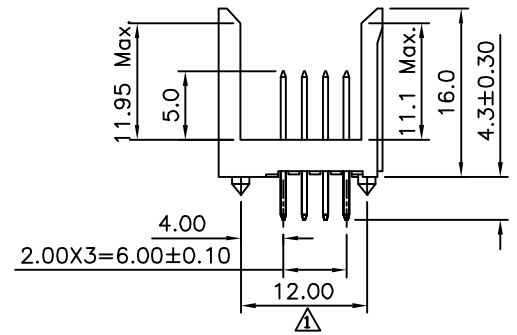
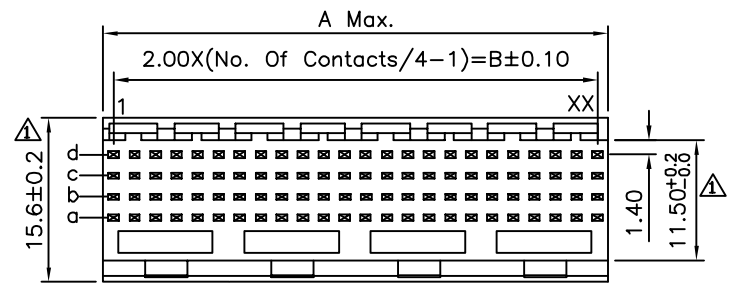
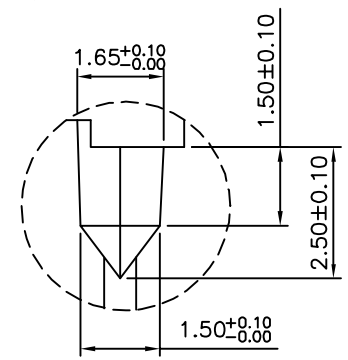
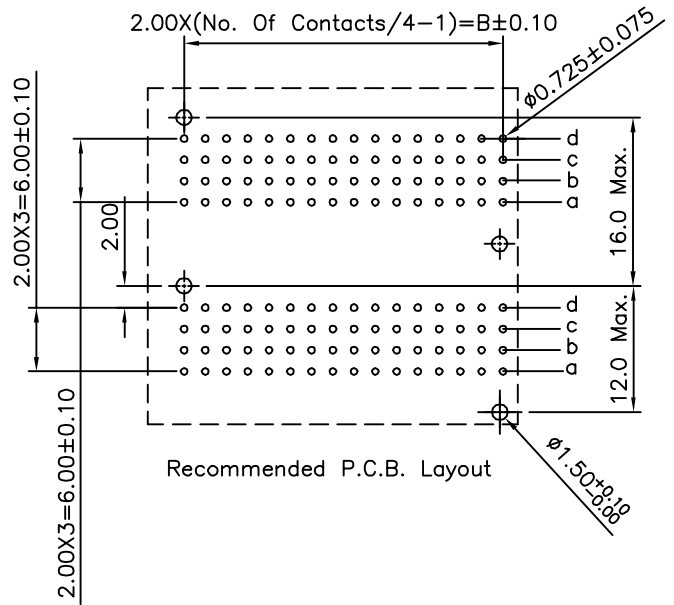
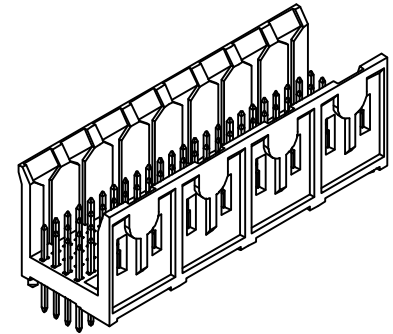

Pin	A	B
24	11.95	10
48	23.95	22
72	35.95	34
96	47.95	46
120	59.95	58
144	71.95	70
168	83.95	82
192	95.95	94

4UCON 元化興業股份有限公司
 4UCON TECHNOLOGY INC.

DRAWING No.		APPROVED BY		UNLESS OTHERWISE SPECIFIED TOLERANCES ARE X. ±0.5 .X ±0.25 .XX ±0.15
18195		MEI		
		CHECKED BY		
		HZF		
		DRAWING BY		
		SONG		
SCALE	NONE	REV.	A1	UNIT
				mm

NO.	REV.	REVISIONS	CHK	DATE
△A1		Modify Data	HZF	03/27/2013
△A0		NEW RELEASE	HZF	01/02/2009