

△ Recommended P.C.B. Layout

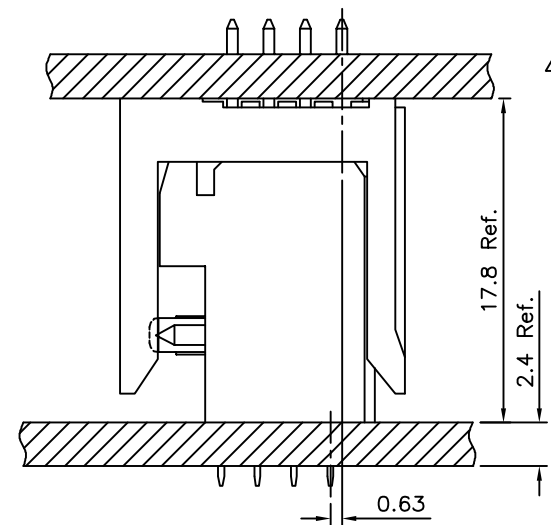

△ Board To Board Offset Application Example

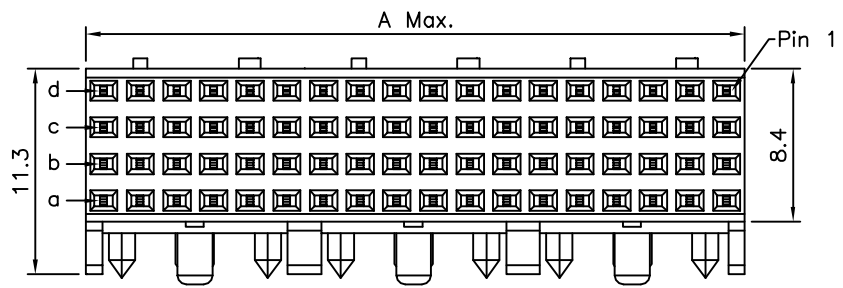

△

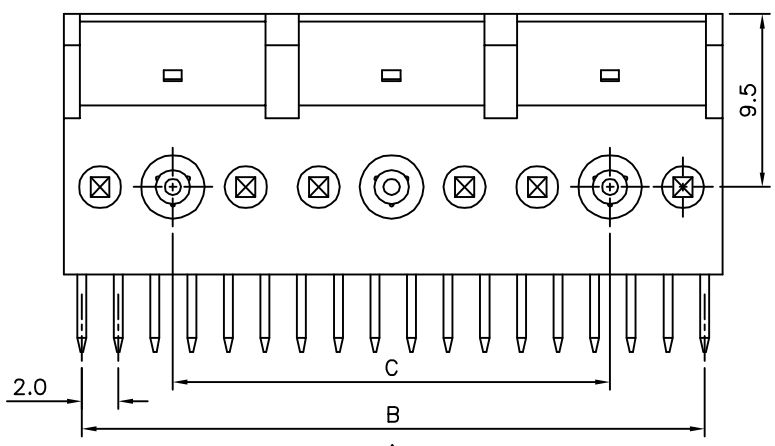

△

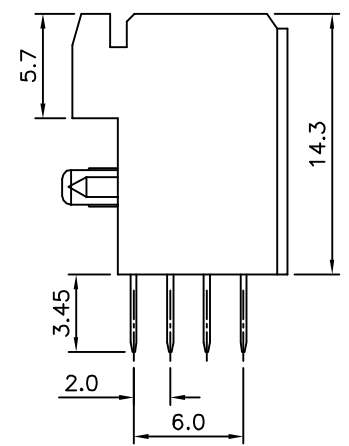

△

**SPECIFICATION**  
 Current Rating:1 Amp  
 Dielectric Withstanding Voltage:AC 1000V For 1 Minute  
 Insulation Resistance:1000 Megaohms Min. At DC 500V  
 Contact Resistance:30 Milliohms Max. At DC 100mA  
 Operation Temperature:-55°C~+125°C  
 Housing:LCP(UL94V-0)  
 Contact:Phosphor Bronze  
 Gold Plated 10u" On Contact Area,Tin  
 Plated On Solder Tails,Over Nickel  
 RoHS Compliant

△

Pin	A	B	C
24	11.95	10.0	0
48	23.95	22.0	12.0
72	35.95	34.0	24.0
96	47.95	46.0	36.0
120	59.95	58.0	48.0
144	71.95	70.0	60.0
168	83.95	82.0	72.0
192	95.95	94.0	84.0

**4UCON** 元化興業股份有限公司  
 4UCON TECHNOLOGY INC.

DRAWING No.		APPROVED BY		UNLESS OTHERWISE SPECIFIED TOLERANCES ARE △ X. ±0.5 .X ±0.25 .XX ±0.15
18241		EMILY		
		CHECKED BY		
		HZF		
		DRAWING BY		
		SONG		
SCALE	NONE	REV.	A1	UNIT mm

NO.	REV.	REVISIONS	CHK	DATE
△ A1		Modify Data	HZF	12/20/2013
△ A0		NEW RELEASE	BECKY	07/01/2005