

SPECIFICATION

Voltage Rating:100V AC,DC
 Current Rating:2A AC,DC
 Withstanding Voltage:800V AC/Minute
 Insulation Resistance:1000 Megaohms Min.
 Contact Resistance:Initial Value/10 Milliohms Max.
 After Environmental Testing 20 Milliohms Max.
 Temperature Range:-40°C~+85°C
 Insulator&Cap:HTN(UL94V-0)
 Contact:High Strength Brass,Tin Plated Over Nickel
 Applicable PC Board Thickness:0.8~1.6mm
 RoHS Compliant

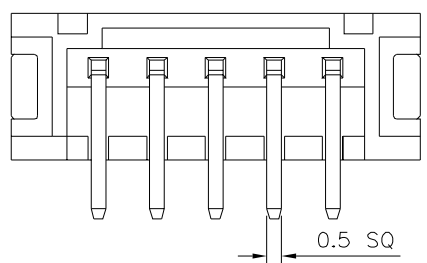
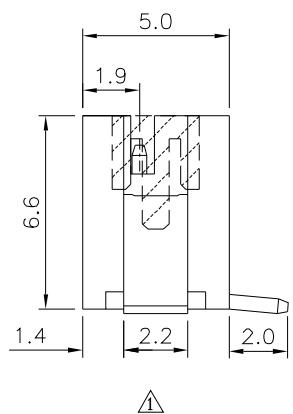
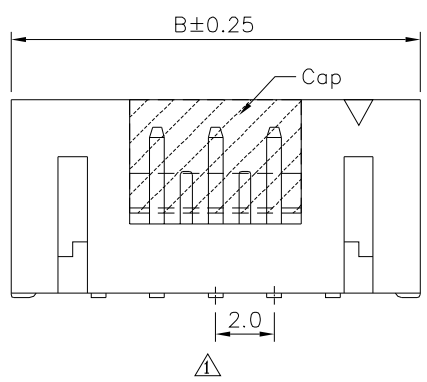
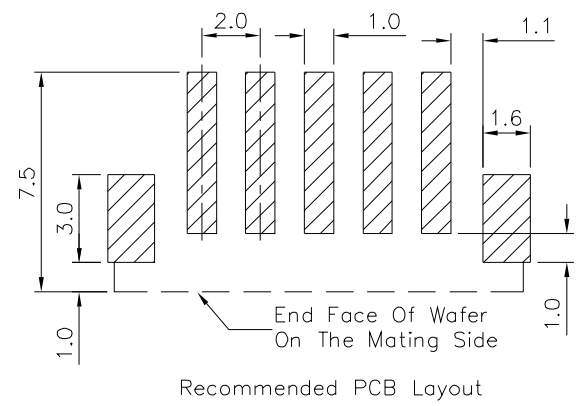
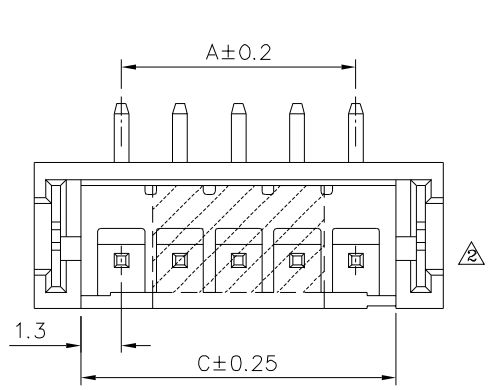

Pin	A	B	C
02	2.00	8.00	4.80
03	4.00	10.00	6.80
04	6.00	12.00	8.80
05	8.00	14.00	10.80
06	10.00	16.00	12.80
07	12.00	18.00	14.80
08	14.00	20.00	16.80
09	16.00	22.00	18.80
10	18.00	24.00	20.80
11	20.00	26.00	22.80
12	22.00	28.00	24.80
13	24.00	30.00	26.80
14	26.00	32.00	28.80
15	28.00	34.00	30.80
16	30.00	36.00	32.80

4UCON 元化興業股份有限公司
 4UCON TECHNOLOGY INC.

DRAWING No. 18665

APPROVED BY MEI
 CHECKED BY HZF
 DRAWING BY CYP

UNLESS OTHERWISE SPECIFIED TOLERANCES ARE
 .X ±0.35
 .XX ±0.25
 ANG.

SCALE NONE REV. A3

NO.	REV.	REVISIONS	CHK	DATE
△3	A3	Modify Data	HZF	08/22/2018
△2	A2	Modify Data	HZF	05/28/2014
△1	A1	Modify Data	HZF	10/24/2012
△0	A0	NEW RELEASE	HZF	04/11/2010

