

Recommended P.C.B. Layout

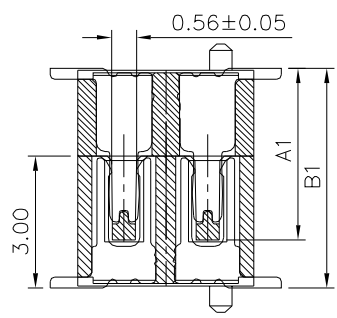
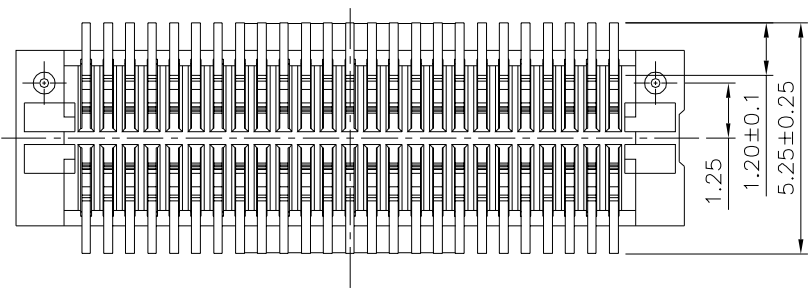

Mating Draw (Ref.)

Part No.(Socket)	Part No.(Plug)	Dim. A1	Dim. B1
1658	1659	3.90	5.0
1660	1659	4.40	5.5

SPECIFICATION

- General Characteristics:**
0.5mm Board To Board Double Slot Type Male XXP
SMT 180° With Post Stacking Height=5.0/5.5mm
With Cap
- Material&Finish:**
△ Housing:LCP(UL94V-0),White
Contact:Phosphor Bronze,Gold Plated Over Nickel
- Electrical Characteristics:**
Current Rating:0.5A AC/DC
Voltage Rating:50V AC/DC
Contact Resistance:30 Milliohms Max.
Insulation Resistance:100 Megaohms Min. At 100V DC
Withstanding Voltage:100V AC For One Minute
- Environmental Characteristics:**
Operation Temperature Range:-20°C~+105°C
- RoHS Compliant**

Pin.	A	B	C	D
10	5.20	2.00	2.96	3.90
20	7.70	4.50	5.46	6.40
30	10.20	7.00	7.96	8.90
40	12.70	9.50	10.46	11.40
50	15.20	12.00	12.96	13.90
60	17.70	14.50	15.46	16.40
70	20.20	17.00	17.96	18.90
80	22.70	19.50	20.46	21.40
90	25.20	22.00	22.96	23.90
100	27.70	24.50	25.46	26.40
120	32.70	29.50	30.46	31.40

Pin	X
10P~48P	5.00
50P~120P	12.0

4UCON 元化興業股份有限公司
4UCON TECHNOLOGY INC.

DRAWING No.		APPROVED BY		UNLESS OTHERWISE SPECIFIED TOLERANCES ARE .X ±0.2 .XX ±0.15 ANG.
18998		MEI		
		CHECKED BY	HZF	
		DRAWING BY	CYP	
SCALE	NONE	REV.	B1	UNIT mm

NO.	REV.	REVISIONS	CHK	DATE
△	B1	Modify Data	HZF	10/15/2018
△	B0	NEW RELEASE	HZF	02/18/2014