

Recommended P.C.B. Layout

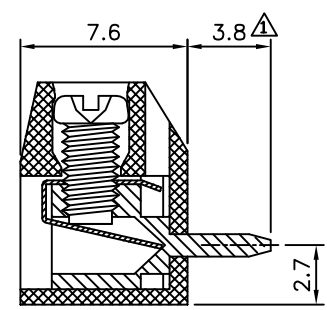
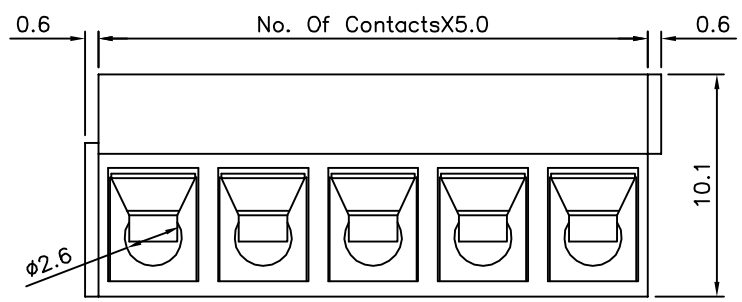
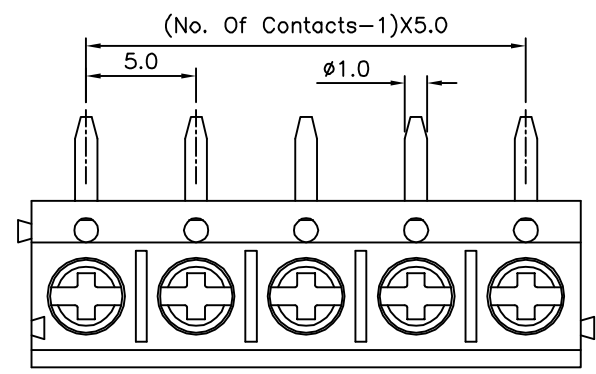

△ SPECIFICATION
 Voltage Rating:250V AC
 Current Rating:15 Amp/Way Max.
 Contact Resistance:20 Milliohms Max.
 Withstanding Voltage:2500V AC (1 Minute)
 Test Time=60 Sec/1 PCS
 Wire Range:14~24 AWG
 Torque:4 kgf.cm/M2.5
 Operation Temperature:-40°C~+105°C
 Soldering Reliability:
 Test Temperature=250°C±10°C/5 Seconds Max.
 Terminal:Copper Alloy,Tin Plated
 Screw:Steel,Galvanized With Cr3+ Plated
 Wire Guard:Stainless Steel
 Insulator Body(Housing):Polyamide(UL94V-0),Blue
 RoHS Compliant

4UCON 元化興業股份有限公司
 4UCON TECHNOLOGY INC.

DRAWING No.		APPROVED BY		UNLESS OTHERWISE SPECIFIED TOLERANCES ARE X. ±0.50 .X ±0.30 .XX ±0.20 ANG. ±1°
19148		EMILY		
		CHECKED BY		
		HZF		
		DRAWING BY		UNIT mm
		YBL		
SCALE	NONE	REV.	A1	

NO.	REV.	REVISIONS	CHK	DATE
△ A1		Modify Data	HZF	02/14/2014
△ A0		NEW RELEASE	HZF	06/27/2010