

**SPECIFICATION**  
 Current Rating:3 A AC/DC  
 Voltage Rating:250V AC Max.  
 Dielectric Withstanding Voltage:1500V AC/Minute  
 Contact Resistance:10 Milliohms Max.  
 Insulation Resistance:1000 Megaohms Min.  
 Operating Temperature:-25°C~+85°C  
 Insulator:PA66 UL94V-2,Natural  
 Terminal:Brass,Tin Plated  
 RoHS Compliant

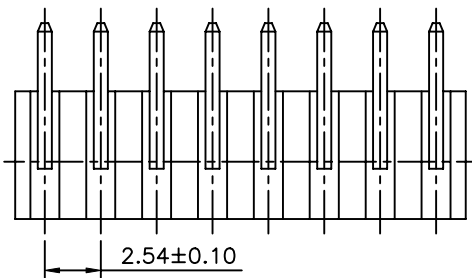
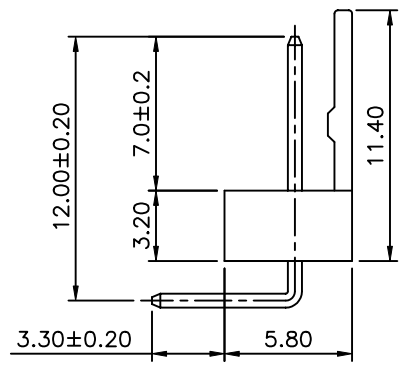
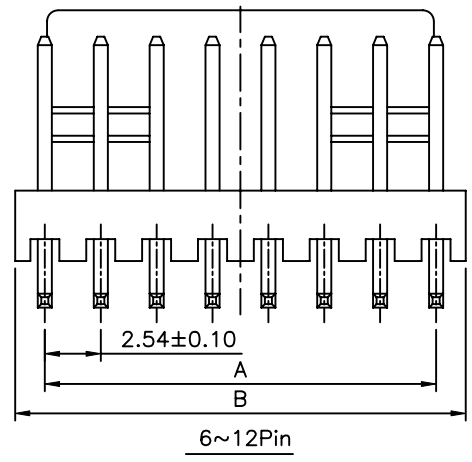
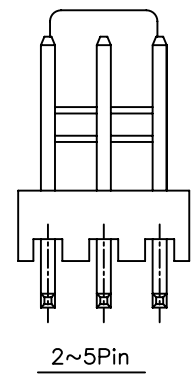
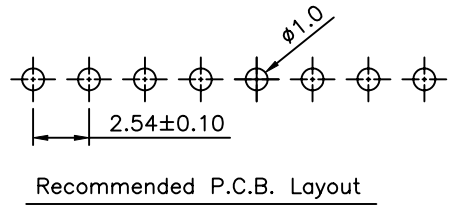
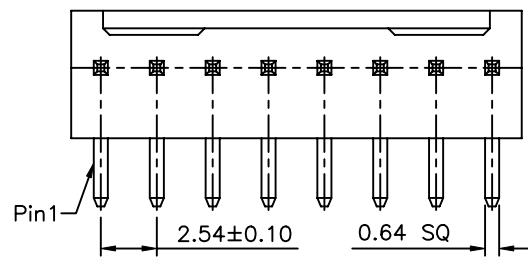
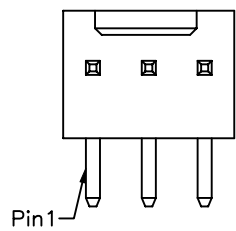

Pin	A	B	Tolerance
2	2.54	5.12	±0.20
3	5.08	7.66	
4	7.62	10.20	
5	10.16	12.74	
6	12.70	15.30	
7	15.24	17.94	±0.30
8	17.78	20.48	
9	20.32	23.02	
10	22.86	25.58	
11	25.40	28.12	
12	27.94	30.68	

**4UCON** 元化興業股份有限公司  
 4UCON TECHNOLOGY INC.

DRAWING No.		APPROVED BY		UNLESS OTHERWISE SPECIFIED TOLERANCES ARE .X ±0.35 .XX ±0.25
19167		MEI		
		CHECKED BY HZF		
		DRAWING BY WZL		
SCALE	NONE	REV.	BO	UNIT mm

NO.	REV.	BO	NEW RELEASE	HZF	11/24/2009
			REVISIONS	CHK	DATE