

Recommended P.C.B. Layout

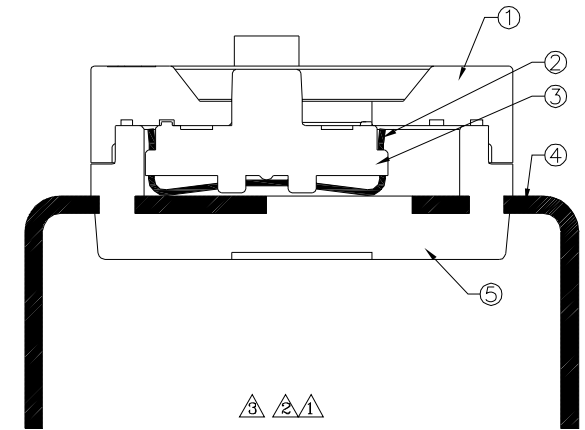

SPECIFICATION

Current Range:
 Non-Switching: 100mA 50V DC
 Switching: 25mA 24V DC
 Dielectric Withstanding Voltage: 500V AC For One Minute
 Contact Resistance: 100 Milliohms Max.(Initial)
 Insulation Resistance: 100 Megaohms Min.
 At 500V DC, 60s ± 5s
 Operation Temperature Range: -40°C ~ +80°C
 RoHS Compliant

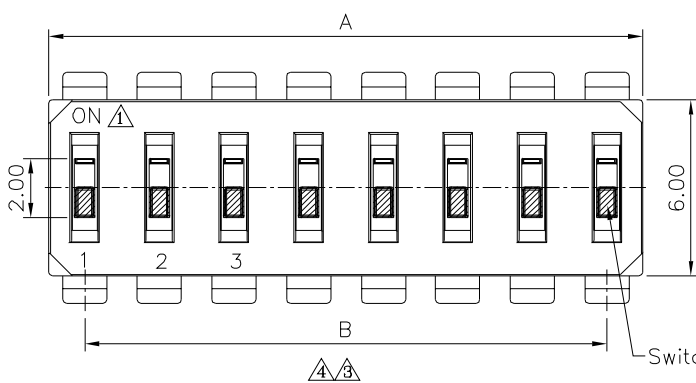

Switch In Off Position

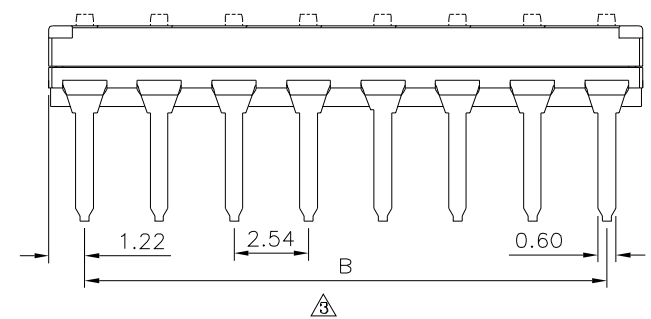
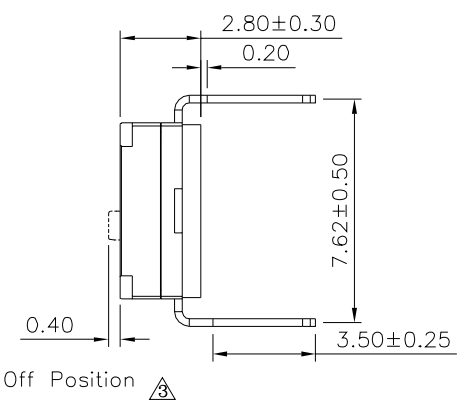

Pin	A	B
1	2.44	2.54
2	4.98	5.08
3	7.52	7.62
4	10.06	10.16
5	12.60	12.70
6	15.14	15.24
7	17.68	17.78
8	20.22	20.32
9	22.76	22.86
10	25.3	27.94
12	30.38	

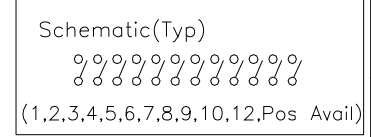

No.	Description	Q'ty	Materials	Remark
①	Cover	1	PA9T,UL94V-0	Black
②	Contact	XX	Beryllium Copper	Gold Plated On Contact Area, Over Nickel
③	Actuator	XX	LCP,UL94V-0	White
④	Terminal	1	Brass	Gold Plated Over Nickel
⑤	Base	1	PA9T,UL94V-0	Black

4UCON 元化興業股份有限公司
 4UCON TECHNOLOGY INC.

DRAWING No. 19487		APPROVED BY MEI		UNLESS OTHERWISE SPECIFIED TOLERANCES ARE .XX ± 0.20
		CHECKED BY HZF		
		DRAWING BY CYP		
SCALE	NONE	REV.	B4	UNIT mm

NO.	REV.	REVISIONS	CHK	DATE
④	B4	Modify Data	HZF	03/19/2022
③	B3	Modify Data	HZF	07/18/2018
②	B2	Modify Data	HZF	09/14/2012
①	B1	Modify Data	HZF	06/17/2011
①	B0	NEW RELEASE	INGRID	08/12/2007