

△ SPECIFICATION
 Rating:DC 30V 0.5A
 Contact Resistance:50 Milliohms Max.
 After Test:100 Milliohms Max.
 Insulation Resistance:100 Megaohms Min. DC 500V
 After Test:50 Megaohms Min.
 Withstand Voltage:500V AC
 Life Test:5000 Cycles Min.
 Operation Temperature Range:-20°C~+70°C
 RoHS Compliant

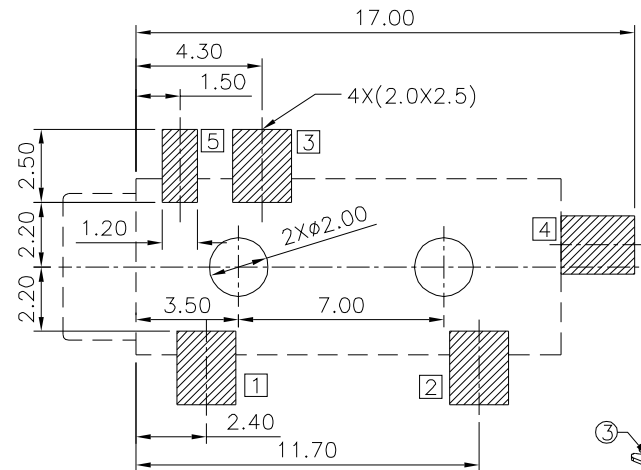

Recommended P.C.B. Layout t=1.2mm
 General Tolerance:±0.05(Top View)

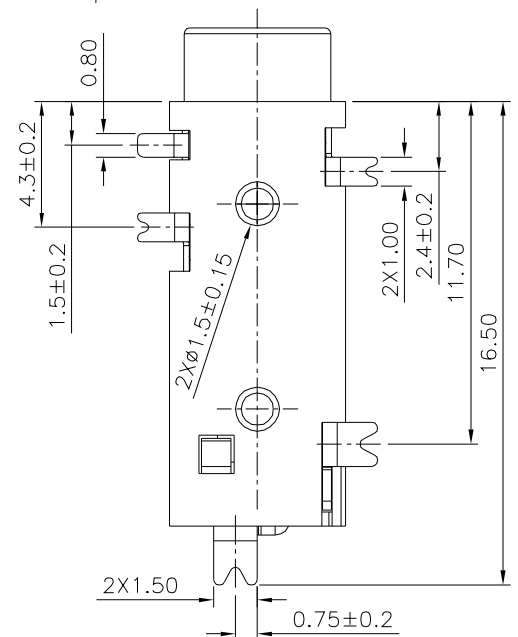
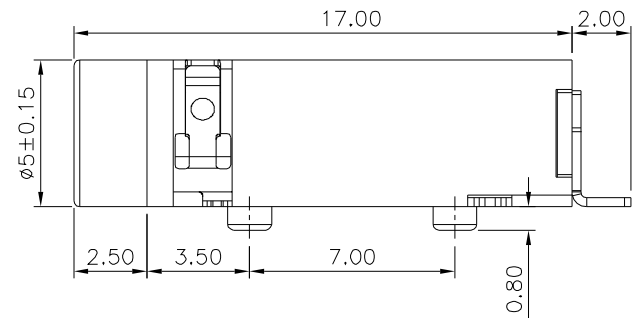
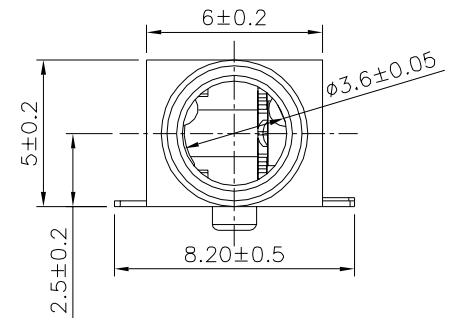
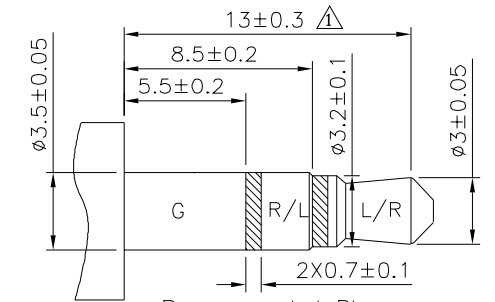
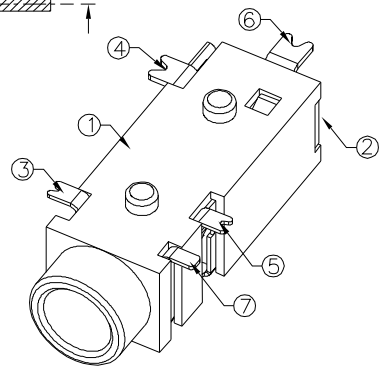

Recommended Plug
 φ3.5 3-Pole Standard Plug

Schematic

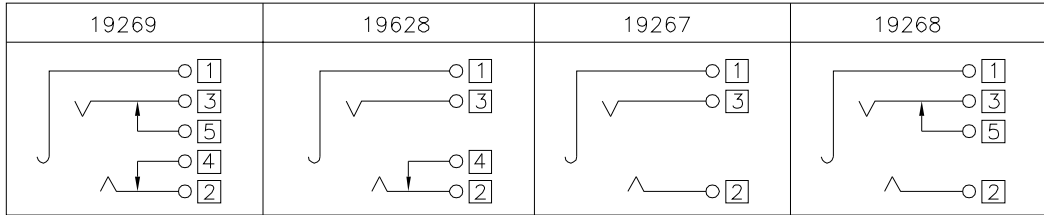

No.	Description	Q'ty	Material	Remark
⑦	Shunt Terminal	1	Phosphor Bronze	Silver Plated
⑥	Shunt Terminal	1	Brass	Silver Plated
⑤	Ring Spring	1	Stainless Steel	Silver Plated
④	Tip Spring	1	Phosphor Bronze	Silver Plated
③	Earth Spring	1	Stainless Steel	Silver Plated
②	Cover	1	PA10T,UL94V-0	Black
①	Housing	1	PA10T,UL94V-0	Black

4UCON 元化興業股份有限公司
 4UCON TECHNOLOGY INC.

DRAWING No.		APPROVED BY	
19628		MEI	
		CHECKED BY	
		HZF	
		DRAWING BY	
		CYP	
SCALE	NONE	REV.	B2

UNLESS OTHERWISE SPECIFIED TOLERANCES ARE
 .X ±0.50 .X* ±5*
 .XX ±0.30 .X* ±3*
 .XXX ±0.15 .X* ±2*

NO.	REV.	REVISIONS	CHK	DATE
△	B2	Modify Data	HZF	07/26/2023
△	B1	Modify Data	HZF	08/18/2017
△	B0	NEW RELEASE	HZF	04/03/2017