

2P To 6P With Wedge,Above
7P Without Wedge(Including 7P)

SPECIFICATION

Voltage Rating:300V AC
 Current Rating:12 Amps/Way Max.
 Contact Resistance:20 Milliohms Max.
 Withstanding Voltage:2500V AC(1 Minute) Test
 Time=60 Sec/1 PCS
 Wire Range:16~24 AWG
 Torque:2.5 Kgf.cm/M2
 Operation Temperature:-40°C~+105°C
 Soldering Reliability:
 Test Temperature=250°C±10°C/5 Seconds Max.
 Contact(Metal Housing):Copper Alloy,Nickel Plated
 Terminal Screw:Steel,Galvanized With Cr3+ Plated
 Wire Guard:Copper Alloy,Tin Plated
 Insulator Body(Housing):Polyamide(UL94V-0),Green
 RoHS Compliant

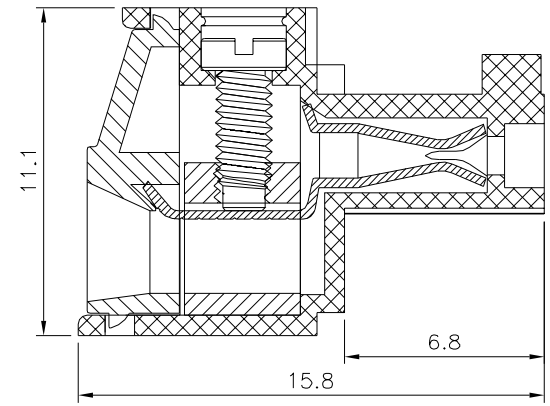
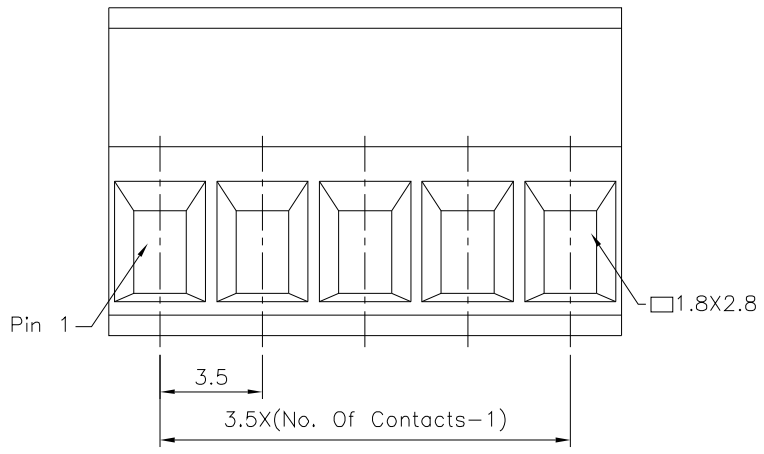

4UCON 元化興業股份有限公司
4UCON TECHNOLOGY INC.

DRAWING No.		APPROVED BY		UNLESS OTHERWISE SPECIFIED TOLERANCES ARE X. ±0.50 .X ±0.30 .XX ±0.20 ANG. ±1°
19842		MEI		
		CHECKED BY HZF		
		DRAWING BY CYP		
SCALE	NONE	REV.	B0	UNIT mm

NO.	REV.	REVISIONS	CHK	DATE
△	B0	NEW RELEASE	HZF	10/04/2018