

Specification

1.General Characteristics :

- . Contact principle: Friction technology
- . Mounting system : SMT
- . Durability 10,000 cycles min.

2. Material

- . Data contacts material : Phosphor Bronze
- . Data contacts plating : Gold or Pd over nickel
- . Insulation Material : Thermoplastic UL 94V-0

3.Electrical Characteristics

- . Card Detecting Switch State: Normally Open.
- . Contact Resistance: 50 milliohms Max.
- . Insulator Resistance: >1000Megohms/500V DC

4.Solderability

- . Wave : not applicable
- . Vapor phase : 215°C, 30 sec. max.
- . IR Reflow : 260°C, 15 sec. max.
- . Manual soldering : 360°C, 3sec. max.

5.Environmental Characteristics

- . Operating Temperature: -40°C~+85°C
- . Operating Humidity: 10%~95% RH
- . Storage temperature : -40°C to +85°C
- . Storage Humidity: 10%~95% RH
- . RoHS Compliant

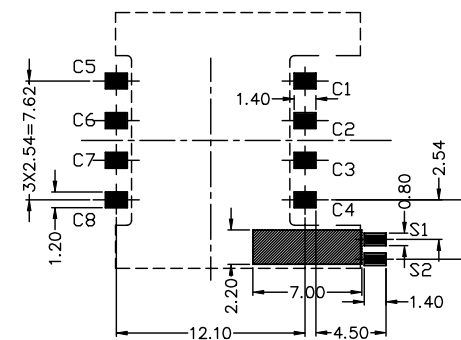
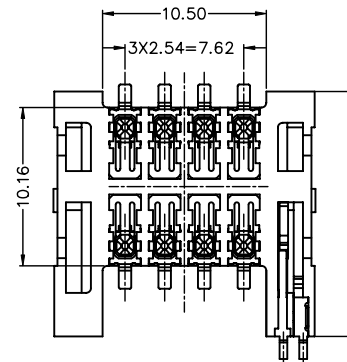
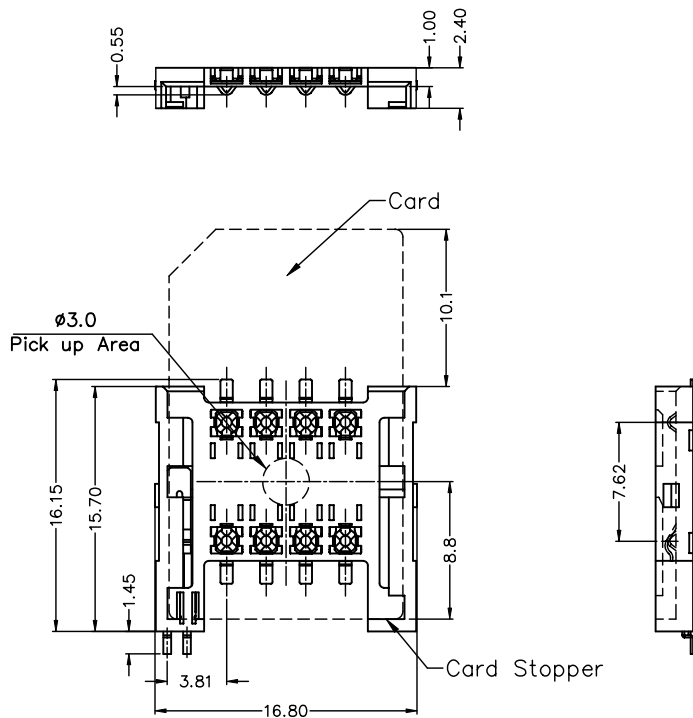
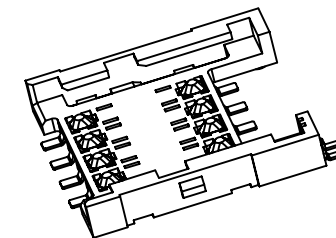

P.C.B LAYOUT(Tolerance: ±0.05mm)

Notes: Please do not plan to design any P.C.B line on the above shadow area, like "▨"

4UCON 元化興業股份有限公司
4UCON TECHNOLOGY INC.

DRAWING No.

19864

APPROVED BY

MEI

CHECKED BY

CATHY

DRAWING BY

QXQ

UNLESS OTHERWISE SPECIFIED TOLERANCES ARE

.X ±0.38

.XX ±0.25

ANG. ±1°

SCALE

NONE

REV.

A1

UNIT

mm



△ A1

ADD REEL PACKING

QXQ

07/20/2010

△ A0

NEW RELEASE

WINKAN

09/23/2010

NO REV.

REVISIONS

CHK

DATE

SPECIFICATIONS:
 Reel Size: 330*32.5 mm
 QTY: 625 Pcs/Reel
 RoHS Compliant

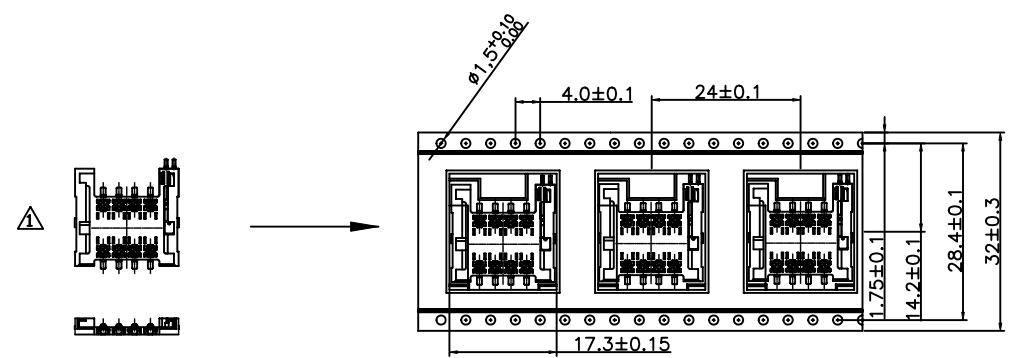

Packing Material Description
 Polystyrene

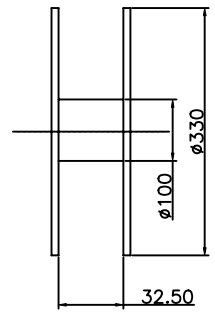
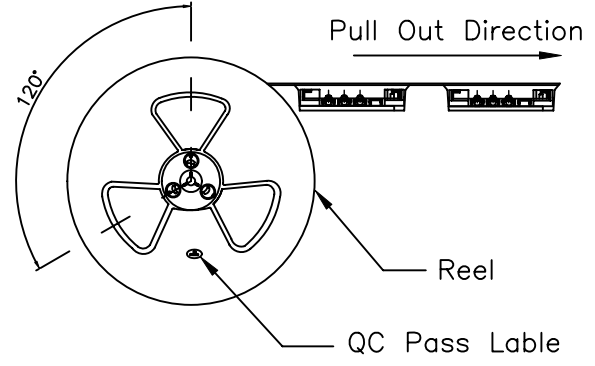
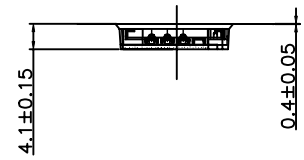

4UCON 元化興業股份有限公司
 4UCON TECHNOLOGY INC.

DRAWING No.		APPROVED BY		UNLESS OTHERWISE SPECIFIED TOLERANCES ARE	
19864		MEI			
		CATHY			
		DRAWING BY		.X ±0.20	
		QXQ		.XX ±0.10	
				ANG. ±1°	
SCALE	NONE	REV.	A1	UNIT	mm

NO.	REV.	REVISIONS	CHK	DATE
△	A1	ADD REEL PACKING	QXQ	07/20/2010
△	A0	NEW RELEASE	WINKAN	09/23/2009