

△ SPECIFICATION

Voltage Rating:150V AC
 Current Rating:6A/Way Max.
 Contact Resistance:20 Milliohms Max.
 Withstanding Voltage:2000V AC For 1 Minute
 Test Time=60s/1 PCS
 Wire Range:18~30 AWG
 Torque:1.5 Kgf.cm/M1.6
 Operation Temperature:-40°C~+105°C
 Soldering Reliability:
 Test Temperature=250°C±10°C/5s Max.
 Contact:Copper Alloy,Nickel Plated
 Terminal Screw:Steel,Galvanized With Cr3+ Plated
 Solder Pin:Copper Alloy,Tin Plated
 Insulator Body(Housing):Polyamide(UL94V-0),Green
 RoHS Compliant

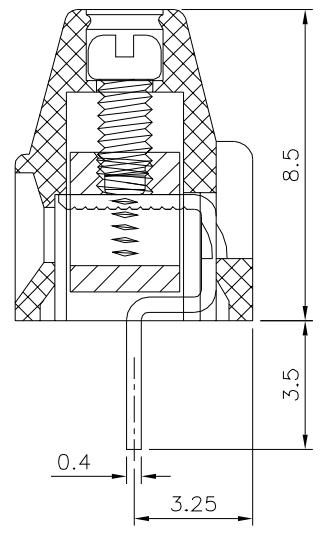
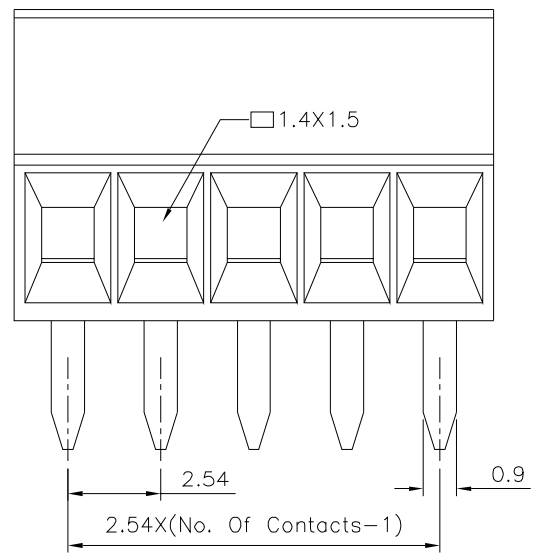

4UCON 元化興業股份有限公司
 4UCON TECHNOLOGY INC.

DRAWING No. 20086		APPROVED BY EMILY		UNLESS OTHERWISE SPECIFIED TOLERANCES ARE X. ±0.50 .X ±0.30 .XX ±0.20 ANG. ±1°
		CHECKED BY HZF		
		DRAWING BY SAN		
SCALE	NONE	REV.	A3	UNIT mm

NO.	REV.	REVISIONS	CHK	DATE
3	A3	Modify Data	HZF	03/21/2014
2	A2	Modify Data	HZF	09/14/2013
1	A1	Modify Data	HZF	07/22/2013
0	A0	NEW RELEASE	HZF	07/26/2009