

Recommended P.C.B. Layout

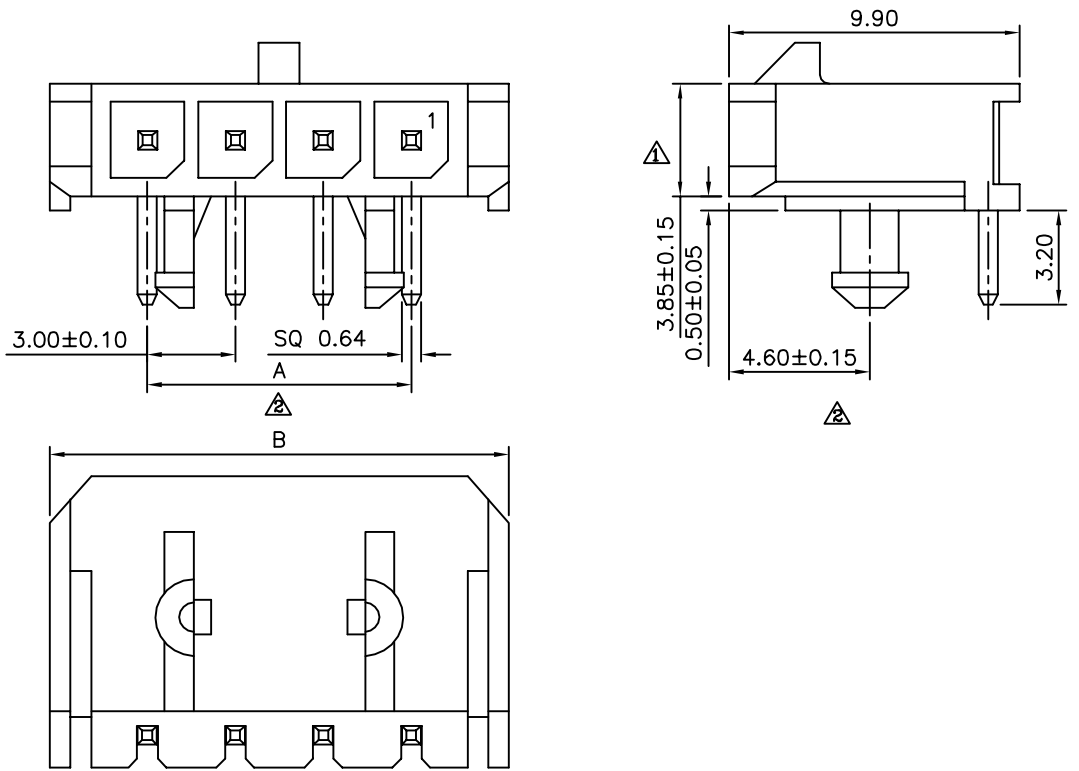

△ SPECIFICATION
1.General Characteristics
 3.0mm Micro Fit 1XXX DIP 90° Male With Post
2.Material&Finish
 Insulator:PBT+30%G.F.(UL94V-0),Black
 Contact:Brass,Tin Plated
3.Electrical Characteristics
 Current Rating:5A AC/DC
 Voltage Rating:250V AC/DC
 Withstand Voltage:1500V AC For 1 Minute
 Contact Resistance:10 Milliohms Max.
 Insulation Resistance:1000 Megaohms Min.
4.Environmental Characteristics
 Operation Temperature Range:-25°C~+85°C
5.RoHS Compliant

△ MIF 1 X XX P RP - H
 (1) (2) (3) (4) (5) (6)

- (1) MIF:3.0mm Micro Fit
- (2) 1:Single Row
- (3) XX:No. Of Position/Per Row
- (4) P:Male
- (5) RP:DIP Right Angle With Post
- (6) H:RoHS Compliant

Pin	A	B	C
1	-	6.65	-
2	3.00	9.65	-
3	6.00	12.65	-
4	9.00	15.65	4.70
5	12.00	18.65	7.70
6	15.00	21.65	10.70
7	18.00	24.65	13.70
8	21.00	27.65	16.70
9	24.00	30.65	19.70
10	27.00	33.65	22.70
11	30.00	36.65	25.70
12	33.00	39.65	28.70

4UCON 元化興業股份有限公司
 4UCON TECHNOLOGY INC.

DRAWING No.		APPROVED BY		UNLESS OTHERWISE SPECIFIED TOLERANCES ARE .X ±0.50 .XX ±0.25 .XXX ±0.10 ANG. ±2°
20143		MEI		
		CHECKED BY	HZF	
		DRAWING BY	WSS	
SCALE	NONE	REV.	A2	UNIT mm

△ A2	Modify Data	HZF	06/21/2011
△ A1	Modify Data	HZF	08/02/2008
△ A0	NEW RELEASE	HZF	11/14/2007
NO.REV.	REVISIONS	CHK	DATE

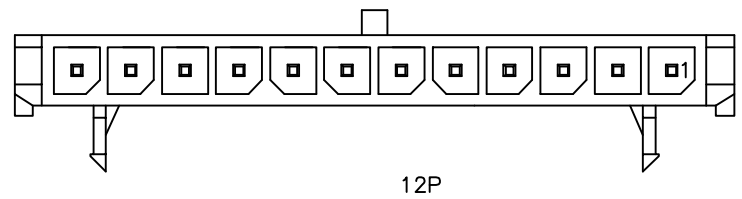
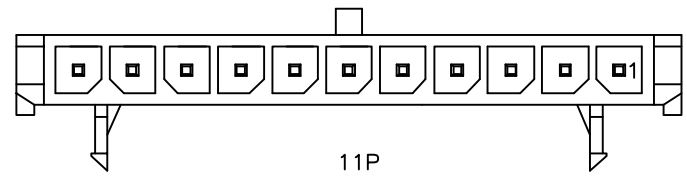
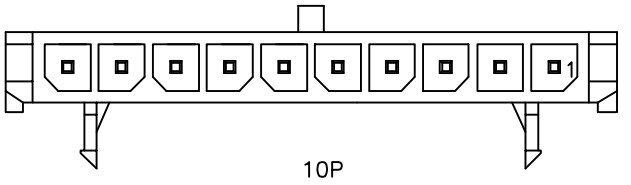
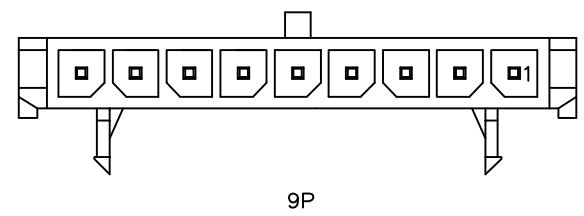
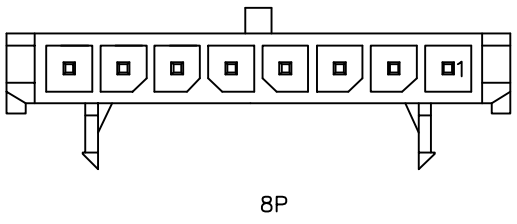
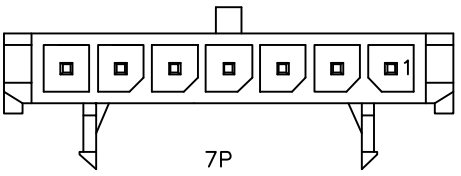
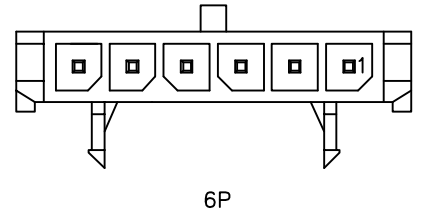
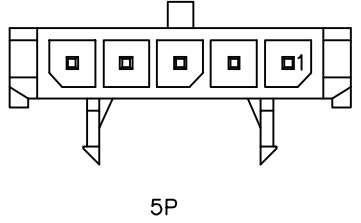
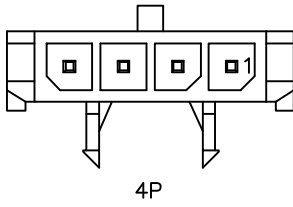
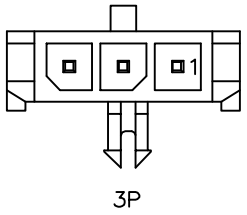
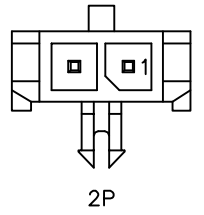

4UCON 元化興業股份有限公司
4UCON TECHNOLOGY INC.

DRAWING No.
20143

APPROVED BY
MEI
CHECKED BY
HZF
DRAWING BY
WSS

SCALE NONE

REV. A2

UNLESS OTHERWISE SPECIFIED TOLERANCES ARE
.X ±0.50
.XX ±0.25
.XXX ±0.10
ANG. ±2'
UNIT mm

NO.	REV.	REVISIONS	CHK	DATE
△A2		Modify Data	HZF	06/21/2011
△A1		Modify Data	HZF	08/02/2008
△A0		NEW RELEASE	HZF	11/14/2007