

**△ SPECIFICATION**

Current Rating:1 Amp  
 Voltage Rating:250V AC RMS  
 Dielectric Withstanding Voltage:500V AC RMS 60Hz  
 For 1 Minute  
 Insulation Resistance:1000 Megaohms Min. At 500V DC  
 Contact Resistance:30 Milliohms Max.  
 Temperature Range:-55°C~+85°C  
 △ Insulator:PPS(UL94V-0),Black  
 △ Contact:Brass  
 Gold Flash On Contact Area,  
 Tin Plated On Solder Tails,Over Nickel  
 RoHS Compliant

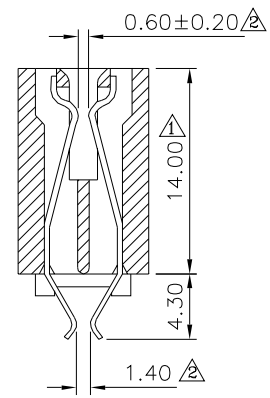
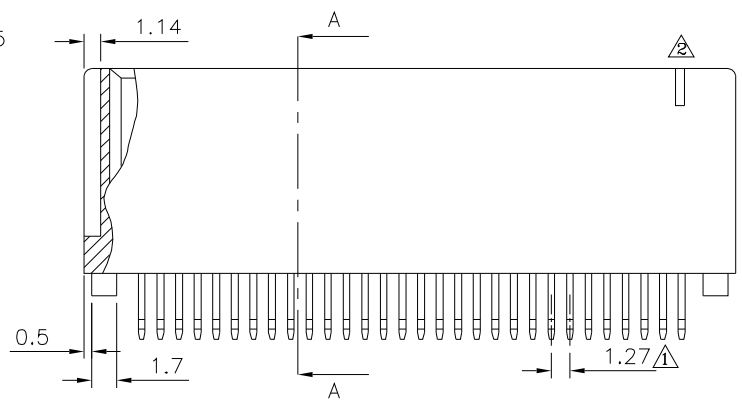
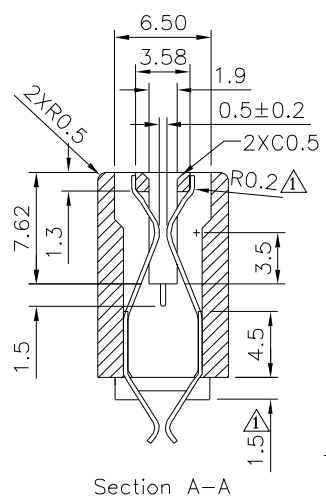
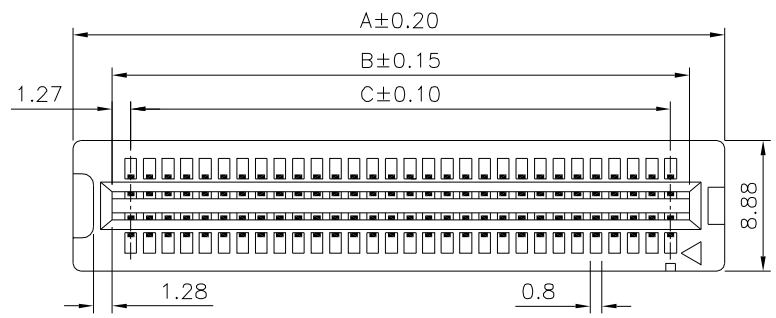

Pin	A	B	C	Pin	A	B	C
04	8.64	3.81	1.27	38	30.23	25.40	22.86
06	9.91	5.08	2.54	40	31.50	26.67	24.13
08	11.18	6.35	3.81	42	32.77	27.94	25.40
10	12.45	7.62	5.08	44	34.04	29.21	26.67
12	13.72	8.89	6.35	46	35.31	30.48	27.94
14	14.99	10.16	7.62	48	36.58	31.75	29.21
16	16.26	11.43	8.89	50	37.85	33.02	30.48
18	17.53	12.70	10.16	52	39.12	34.29	31.75
20	18.80	13.97	11.43	54	40.39	35.56	33.02
22	20.07	15.24	12.70	56	41.66	36.83	34.29
24	21.34	16.51	13.97	58	42.93	38.10	35.56
26	22.61	17.78	15.24	60	44.20	39.37	36.83
28	23.88	19.05	16.51	80	56.90	52.07	49.53
30	25.15	20.32	17.78	100	69.60	64.77	62.23
32	26.42	21.59	19.05	120	82.30	77.47	74.93
34	27.69	22.86	20.32	124	84.84	80.01	77.47
36	28.96	24.13	21.59	140	95.00	90.17	87.63

**4UCON** 元化興業股份有限公司  
 4UCON TECHNOLOGY INC.

DRAWING No. **20928**

APPROVED BY MEI  
 CHECKED BY HZF  
 DRAWING BY CYP

UNLESS OTHERWISE SPECIFIED TOLERANCES ARE  
 0~10 ±0.2  
 10~30 ±0.3  
 30~100 ±0.4  
 100~300 ±0.5  
 300~ ANG. ±0.5

SCALE NONE REV. A3 UNIT mm

NO.	REV.	REVISIONS	CHK	DATE
△ A3		Modify Data	HZF	12/02/2018
△ A2		Modify Data	HZF	04/28/2016
△ A1		Modify Data	HZF	02/27/2013
△ A0		NEW RELEASE	BECKY	2004/06/06