

Recommended P.C.B. Layout

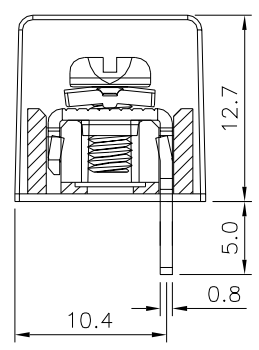
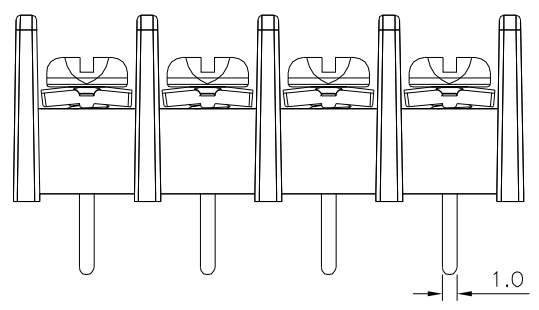
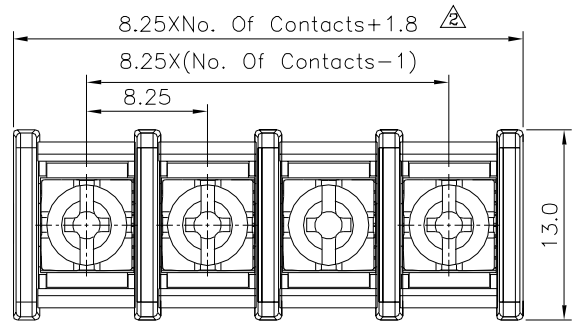

SPECIFICATION
 Current Rating:20 Amps/Way Max.
 Voltage Rating:300V AC
 Contact Resistance:20 Milliohms Max.
 Operation Temperature:-40°C~+105°C
 Soldering Reliability:Test Temperature:
 250°C±10°C/5s Max.
 Withstanding Voltage:2500V AC (1 Minute)
 Test Time=60s/1 PCS
 Wire Range:12~22 AWG
 Torque:10 Kgf.cm/M3.0
 ⚠ Insulator Body(Housing):PA66+G.F.(UL94V-0),Black
 Terminals:Copper Alloy,Tin Plated
 Terminal Screw:Steel,Galvanized With Cr3+ Plated
 RoHS Compliant

4UCON 元化興業股份有限公司
 4UCON TECHNOLOGY INC.

DRAWING No. ⚠
 21451
 SCALE NONE

APPROVED BY MEI
 CHECKED BY HZF
 DRAWING BY CYP
 REV. A2

UNLESS OTHERWISE SPECIFIED TOLERANCES ARE
 X. ±0.50
 .X ±0.30
 .XX ±0.20
 ANG. ±1°
 UNIT mm

NO.	REV.	REVISIONS	CHK	DATE
⚠	A2	Modify Data	HZF	09/20/2018
⚠	A1	Modify Data	HZF	05/09/2018
⚠	A0	NEW RELEASE	HZF	01/03/2016