

**SPECIFICATION**  
 ⚠ Insulator:ABS(UL94HB)  
 Screw,Nut&SR:Steel,Nickel Plated  
 Packing:1 Set/Bag  
 RoHS Compliant

Hood Insulator Color	Item No.
Chromate Plated	06895
Gray	16160
Black	21674

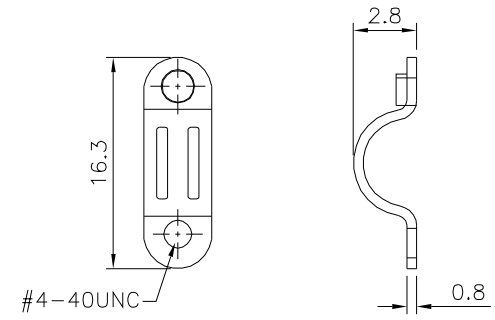
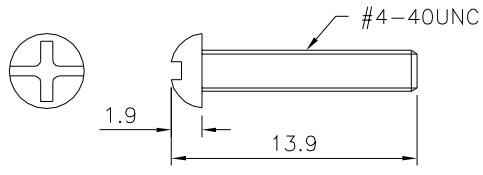
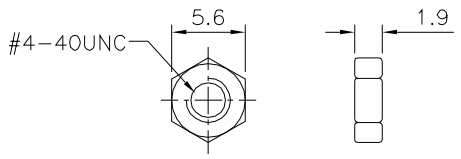
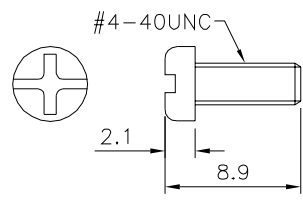
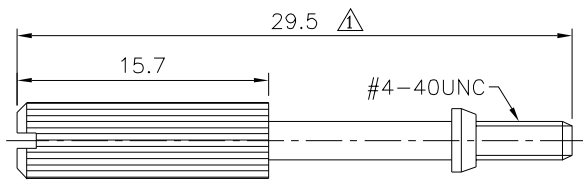
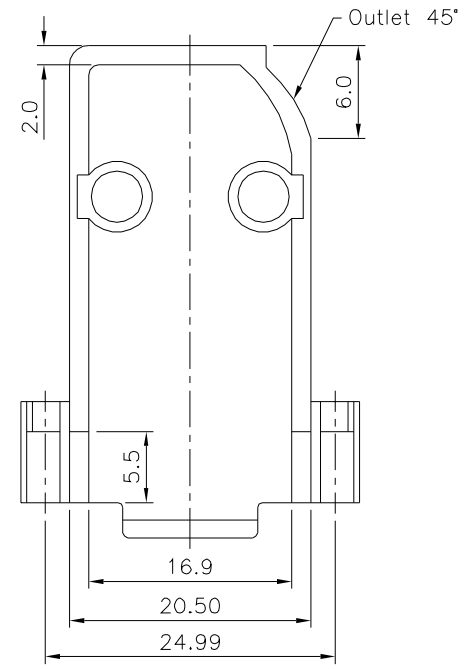
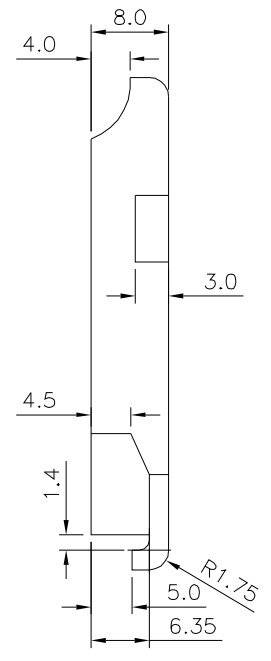
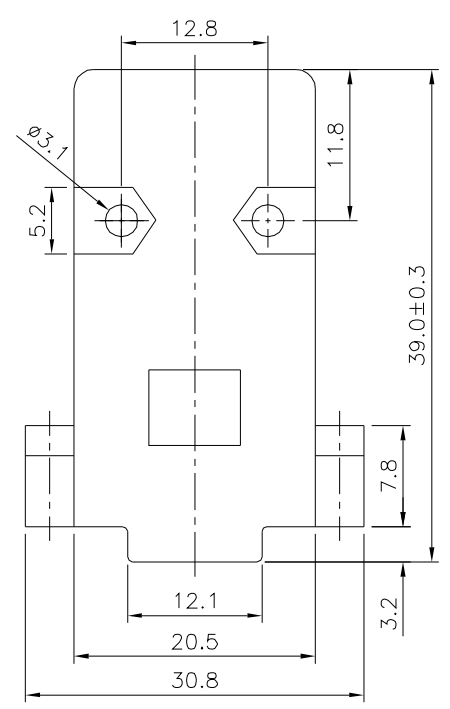

**4U CON** 元化興業股份有限公司  
 4U CON TECHNOLOGY INC.

DRAWING No.		APPROVED BY		UNLESS OTHERWISE SPECIFIED TOLERANCES ARE .X ±0.38 .XX ±0.25 ANG.
21674		MEI		
		CHECKED BY		
		HZF		
		DRAWING BY		UNIT mm
		SONG		
SCALE	NONE	REV.	A2	NO. REV.

NO.	REV.	REVISIONS	CHK	DATE
2	A2	Modify Data	HZF	07/09/2014
1	A1	Modify Data	HZF	12/10/2008
0	A0	NEW RELEASE	HZF	02/07/2008