

SPECIFICATION
 Current Rating: 16 Amps/Way Max.
 Voltage Rating: 300V AC
 Withstanding Voltage: 2500V AC (1 Minute) Test Time = 60Sec./1PCS
 Contact Resistance: 20 Milliohms Max.
 Operation Temperature: -40°C ~ +105°C
 Torque: 4.5kgf.cm/M2.5
 Soldering Reliability: 250°C ± 10°C / 5 Seconds Max.
 Wire Range: 12~30AWG
 Insulator Body (Housing): Polyamide (UL94V-0), Green
 Contact (Metal Housing): Copper Alloy, Nickel Plated
 Terminal Screw: Steel Galvanized With Cr3+ Plated
 Solder Pin: Copper Alloy, Tin Plated
 RoHS Compliant

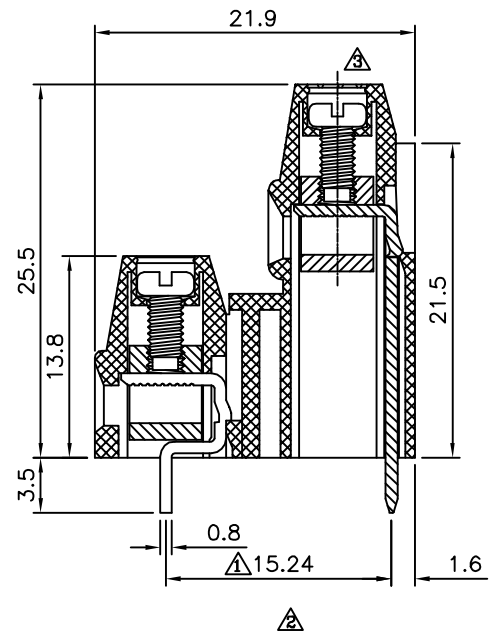
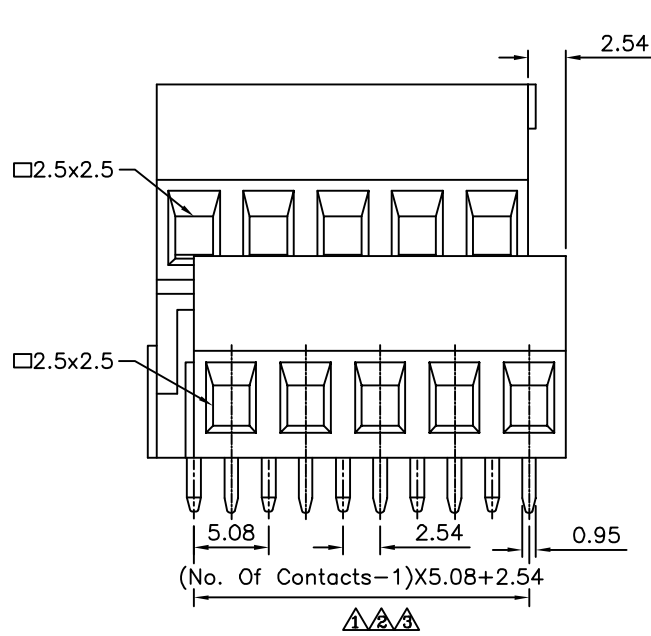

4UCON 元化興業股份有限公司
 4UCON TECHNOLOGY INC.

DRAWING No.		APPROVED BY		UNLESS OTHERWISE SPECIFIED TOLERANCES ARE X. ±0.50 .X ±0.30 .XX ±0.20 ANG. ±1°
21898		MEI		
		CHECKED BY	HZF	
		DRAWING BY	HAO	
SCALE	NONE	REV.	A3	UNIT mm

\triangle A3	Modify Data	HZF	11/16/2015
\triangle A2	Modify Data	HZF	10/24/2015
\triangle A1	Modify Data	HZF	06/18/2010
\triangle A0	NEW RELEASE	HZF	06/02/2009
NO. REV.	REVISIONS	CHK	DATE