

Recommended P.C.B. Layout (Top Side)
(PCB Board Tolerance ±0.05)

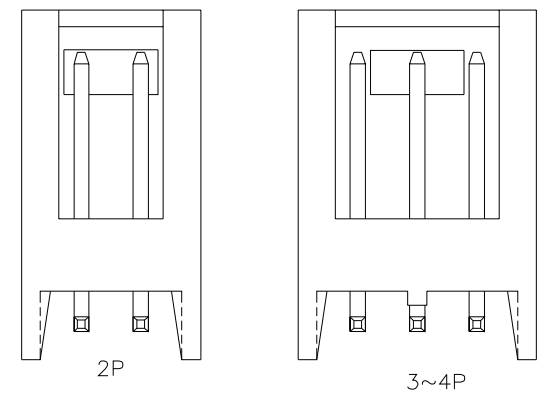
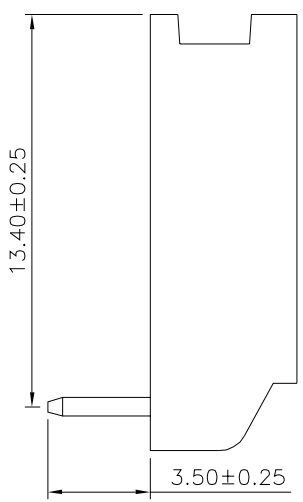
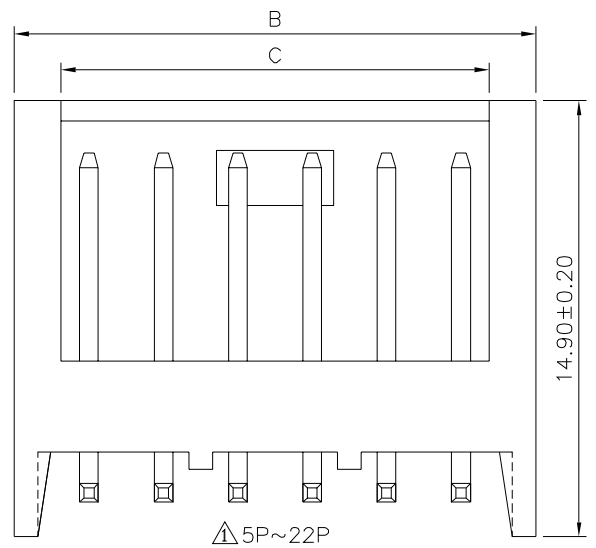
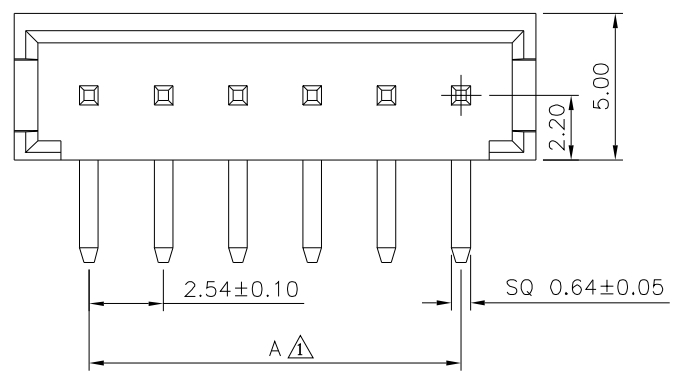

△ SPECIFICATION
 Current Rating: 3.0 Amp
 Voltage Rating: 250V AC/DC
 Withstand Voltage: 1000V AC/Minute
 Contact Resistance: 20 Milliohms Max.
 Insulation Resistance: 1000 Megaohms Min.
 Operation Temperature: -25°C ~ +85°C
 Contact: Brass, Tin Plated Over Nickel
 Insulator: PA9T (UL94V-0), Black
 RoHS Compliant

2~12P	A	2.54X(No. Of Contacts-1)±0.20
	B	2.54XNo. Of Contacts+2.54±0.25
	C	2.54XNo. Of Contacts-0.64±0.25
13~22P	A	2.54X(No. Of Contacts-1)±0.25
	B	2.54XNo. Of Contacts+2.54±0.30
	C	2.54XNo. Of Contacts-0.64±0.30

4UCON 元化興業股份有限公司
4UCON TECHNOLOGY INC.

DRAWING No. 22461		APPROVED BY MEI		UNLESS OTHERWISE SPECIFIED TOLERANCES ARE .X ±0.40 .XX ±0.25 .XXX ±0.15 ANG. ±3°
		CHECKED BY HZF		
		DRAWING BY CYP		
SCALE	NONE	REV.	A1	
		UNIT	mm	

NO.	REV.	REVISIONS	CHK	DATE
△ A1		Modify Data	HZF	08/10/2020
△ A0		NEW RELEASE	HZF	01/28/2017