

**SPECIFICATION**

Current Rating:3A(AWG#24)AC,DC  
 Voltage Rating:100V AC,DC  
 Withstand Voltage:500V AC/Minute  
 Insulation Resistance:500 Megaohms Min.  
 Contact Resistance:20 Milliohms Max.  
 Temperature Range:-40°C~+105°C  
 Insulator:PA9T(UL94V-0),Nature  
 Pin:Phosphor Bronze,Tin Plated Over Nickel  
 Fitting Nail:Brass,Tin Plated Over Nickel  
 RoHS Compliant

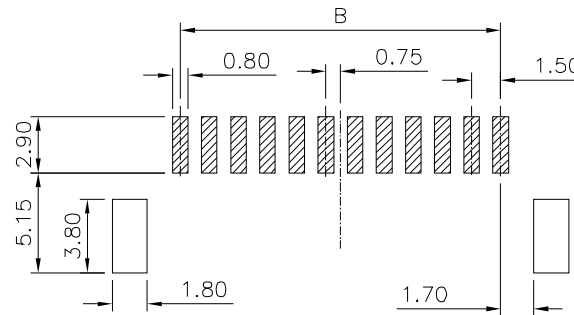
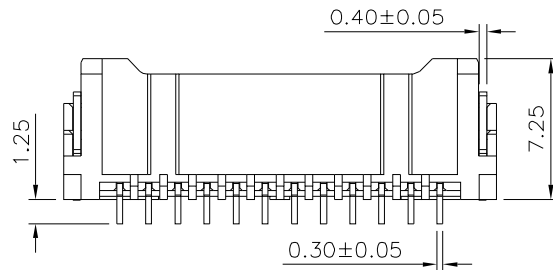
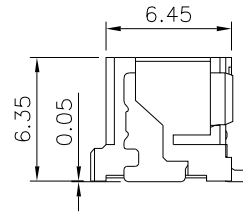
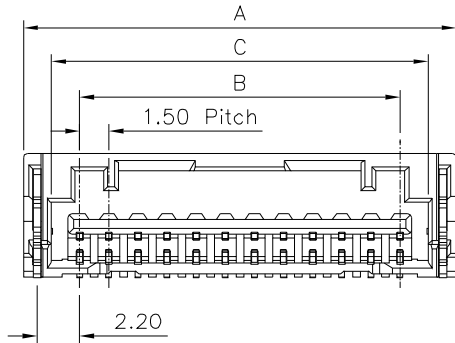
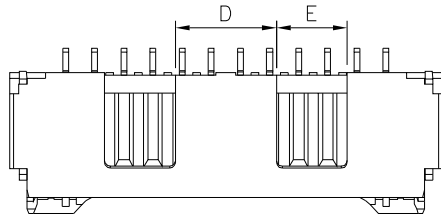

Recommended P.C.B. Layout  
 (PCB Board Tolerance±0.05)

Pin	A	B	C	D	E
2P	7.30	1.50	4.40	—	1.85
3P	8.80	3.00	5.90	—	2.55
4P	10.30	4.50	7.40	—	3.30
5P	11.80	6.00	8.90	—	3.60
6P	13.30	7.50	10.40	2.30	2.15
7P	14.80	9.00	11.90	2.50	2.50
8P	16.30	10.50	13.40	2.50	3.25
9P	17.80	12.00	14.90	3.20	3.65
10P	19.30	13.50	16.40	3.20	
11P	20.80	15.00	17.90	5.20	
12P	22.30	16.50	19.40	5.20	
13P	23.80	18.00	20.90	5.20	
14P	25.30	19.50	22.40	5.20	
15P	26.80	21.00	23.90	5.20	

**4UCON** 元化興業股份有限公司  
 4UCON TECHNOLOGY INC.

DRAWING No.

22491

APPROVED BY

EMI

CHECKED BY

HZF

DRAWING BY

LZX

UNLESS OTHERWISE SPECIFIED TOLERANCES ARE  
 .X ±0.30  
 .XX ±0.20  
 .XXX ±0.10  
 ANG. ±2°

SCALE

NONE

REV.

A0

UNIT

mm

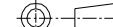

NO. REV.

A0 NEW RELEASE

REVISIONS

HZF

09/28/2022

CHK

DATE

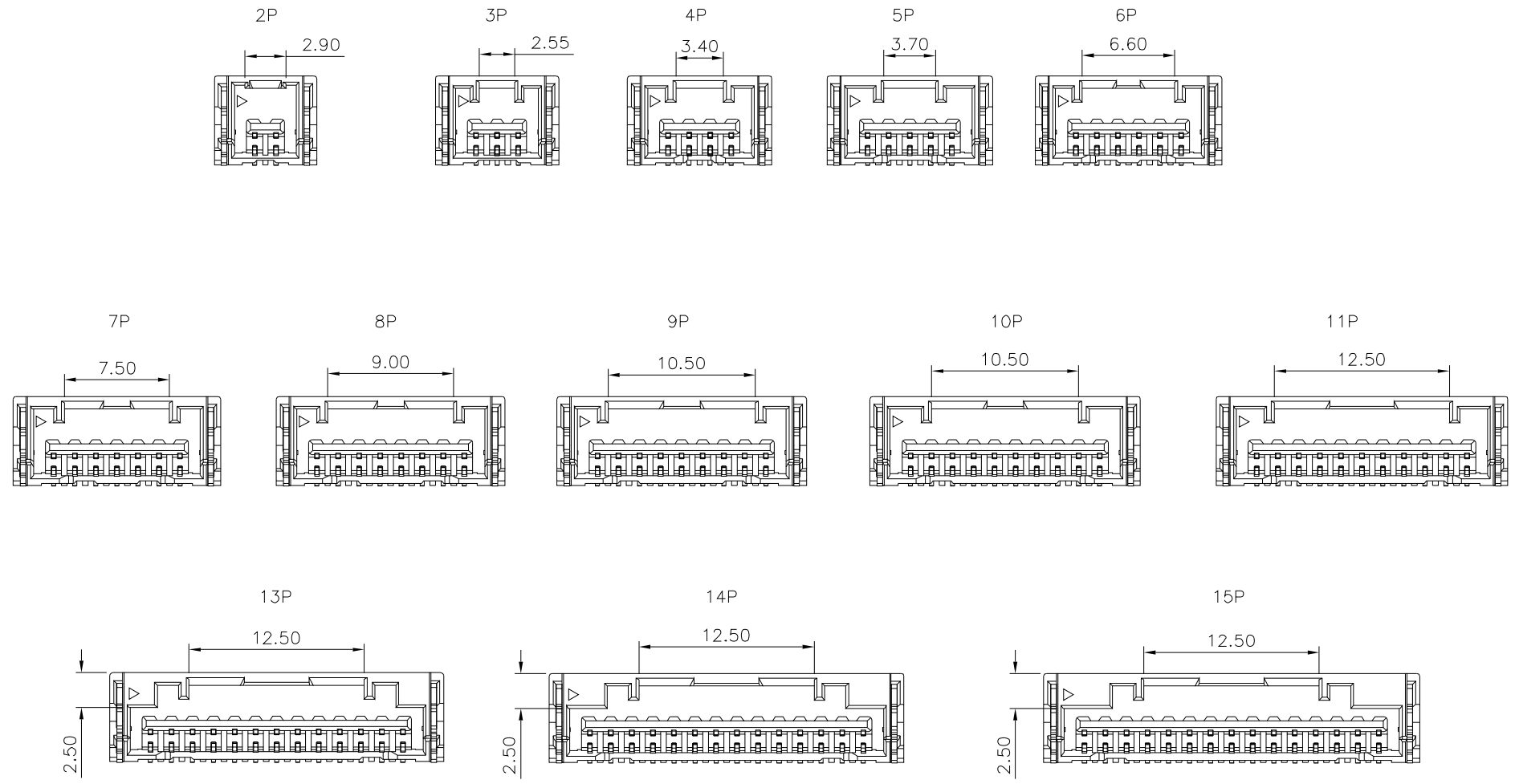

**4UCON** 元化興業股份有限公司  
4UCON TECHNOLOGY INC.

DRAWING No.		APPROVED BY		UNLESS OTHERWISE SPECIFIED TOLERANCES ARE .X ±0.30 .XX ±0.20 .XXX ±0.10 ANG. ±2°
22491		EMI		
		CHECKED BY HZF		
		DRAWING BY LZX		
SCALE	NONE	REV.	A0	UNIT mm

NO.	REV.	REVISIONS	CHK	DATE
△ A0		NEW RELEASE	HZF	09/28/2022