

SPECIFICATION

Applicable Wire Range:
 (Outside Wire Insulation: 2.1mm Dia. Max.)
 Solid Wire: AWG #24~#18
 Strand Wire: AWG #22~#20
 Contact: Phosphor Bronze, Tin Plated Over Nickel
 Insulator: PA9T(UL94V-0), Cream
 Cover: PA9T(UL94V-0), Cream
 RoHS Compliant

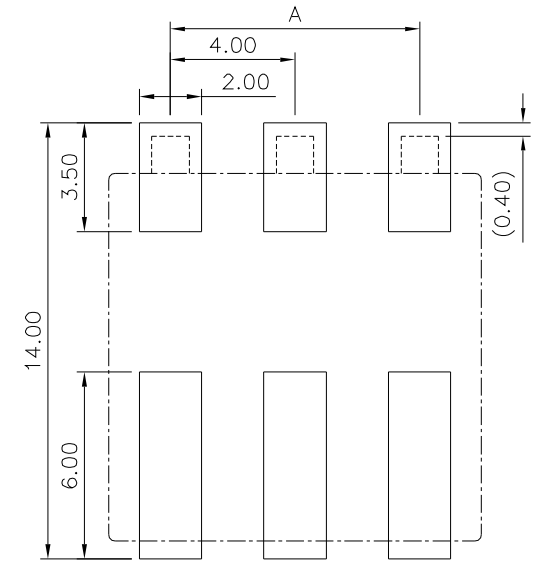

Recommended P.C.B. Layout
 Tolerance: ± 0.05 (Top View)

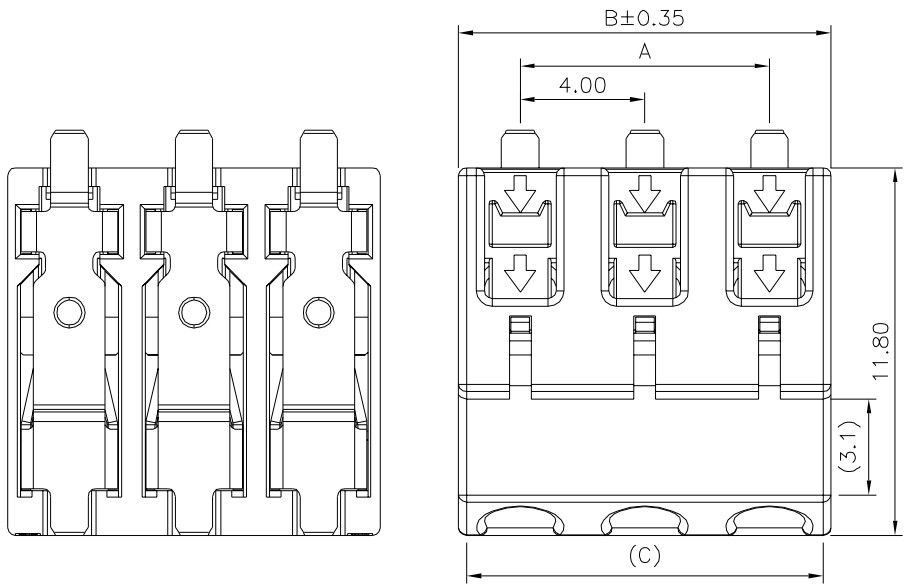
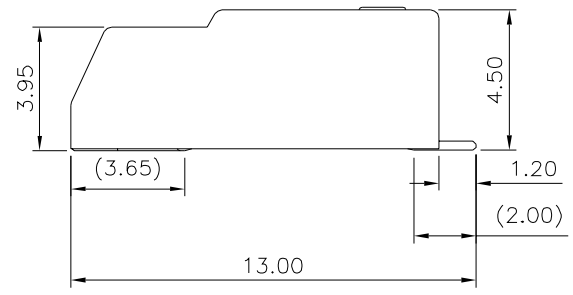
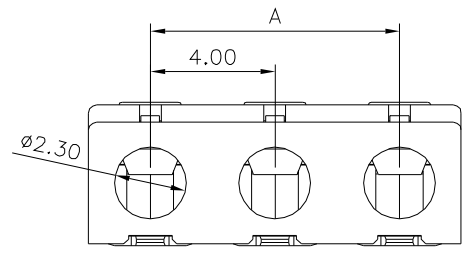

Pin	A	B	C
01	--	3.95	3.45
02	4.00	7.95	7.45
03	8.00	11.95	11.45

4UCON 元化興業股份有限公司
 4UCON TECHNOLOGY INC.

DRAWING No.
22778

APPROVED BY MEI
 CHECKED BY HZF
 DRAWING BY LSM

UNLESS OTHERWISE SPECIFIED TOLERANCES ARE
 .X ± 0.25
 .XX ± 0.15
 ANG. $\pm 3^\circ$

SCALE NONE REV. A0

UNIT mm

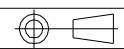

NO.	REV.	REVISIONS	CHK	DATE
△ A0		NEW RELEASE	HZF	03/10/2024