

4P~15P

**△ SPECIFICATION**  
 Insulator:PA66(UL94V-0)  
 RoHS Compliant

Pin	A	B	C
2	6.00	2.00	4.80
3	8.00	4.00	6.80
4	10.00	6.00	8.80
5	12.00	8.00	10.80
6	14.00	10.00	12.80
7	16.00	12.00	14.80
8	18.00	14.00	16.80
9	20.00	16.00	18.80
10	22.00	18.00	20.80
11	24.00	20.00	22.80
12	26.00	22.00	24.80
13	28.00	24.00	26.80
14	30.00	26.00	28.80
15	32.00	28.00	30.80

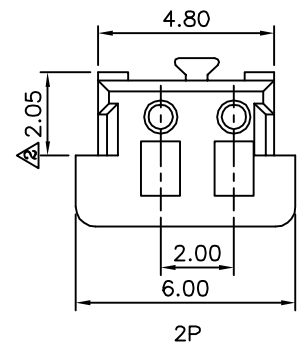
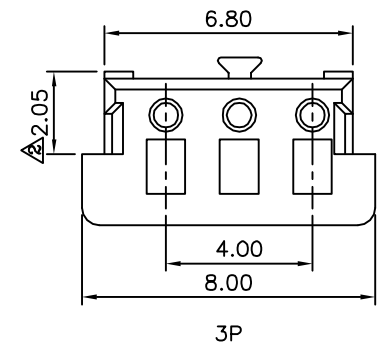
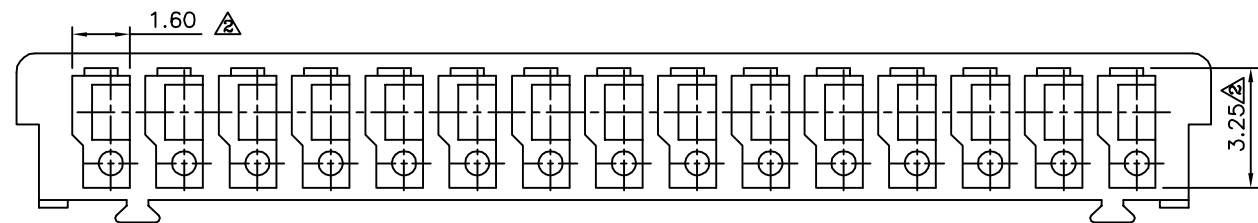
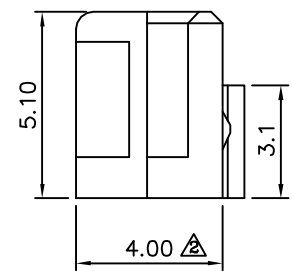
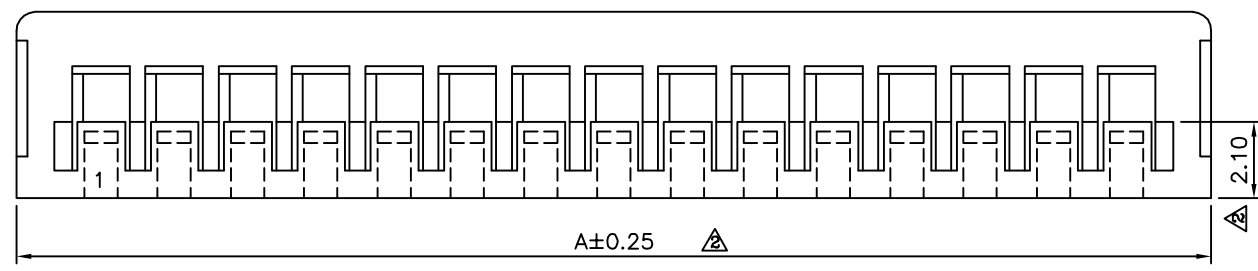

**4UCON** 元化興業股份有限公司  
 4UCON TECHNOLOGY INC.

DRAWING No.		APPROVED BY		UNLESS OTHERWISE SPECIFIED TOLERANCES ARE .X ±0.25 .XX ±0.15 .XXX ±0.08
11558		EMILY		
		CHECKED BY		
		HZF		
		DRAWING BY		UNIT mm
		YBL		
SCALE	NONE	REV.	A3	

NO.	REV.	REVISIONS	CHK	DATE
△ A3		Modify Data	HZF	11/06/2013
△ A2		Modify Data	HZF	09/28/2011
△ A1		Modify Data	INGRID	12/11/2007
△ A0		NEW RELEASE		