

SPECIFICATION
 Current Rating:1.0A AC/DC
 Voltage Rating:200V AC/DC
 Withstanding Voltage:500V AC/Minute
 Contact Resistance:20 Milliohms Max.
 Insulation Resistance:100 Megaohms Min.
 Temperature Range:-25°C~+85°C
 Material:PA66+15%G.F.(UL94V-0),Black
 RoHS Compliant

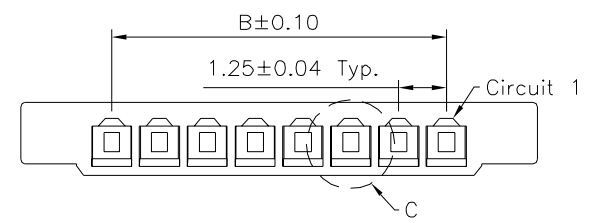
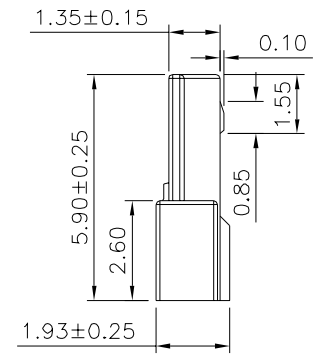
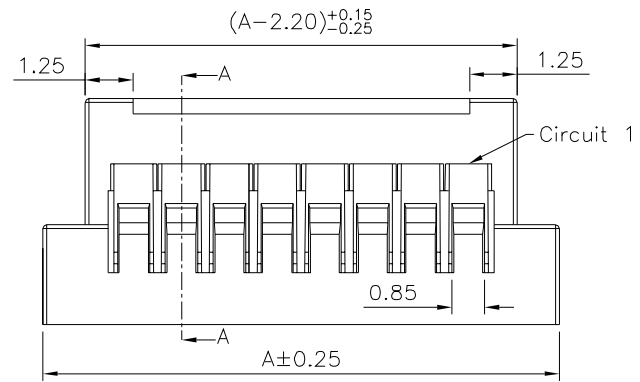
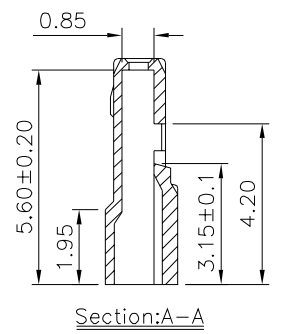
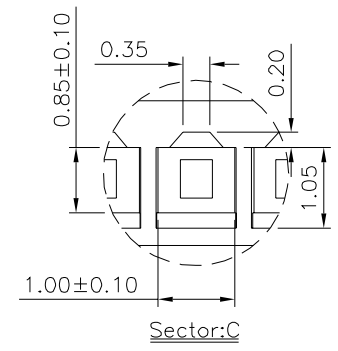
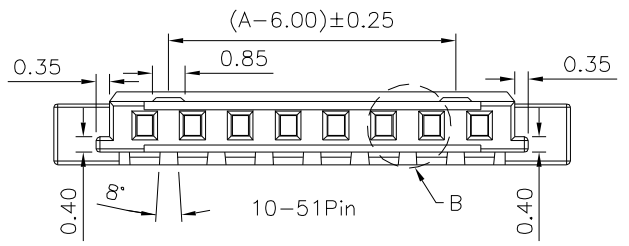
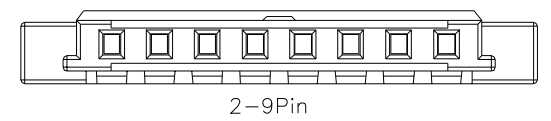
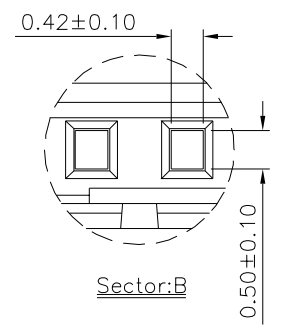

Pin	A	B
02	6.00	1.25
03	7.25	2.50
04	8.50	3.75
05	9.75	5.00
06	11.00	6.25
07	12.25	7.50
08	13.50	8.75
09	14.75	10.00
10	16.00	11.25
20	28.50	23.75
21	29.75	25.00
30	41.00	36.25
41	54.75	50.00
51	67.25	62.50

4UCON 元化興業股份有限公司
 4UCON TECHNOLOGY INC.

DRAWING No. 12895
 SCALE NONE

APPROVED BY MEI
 CHECKED BY HZF
 DRAWING BY CYP
 REV. A1

UNLESS OTHERWISE SPECIFIED TOLERANCES ARE
 .X ±0.25 .X* ±2*
 .XX ±0.20 .XX* ±1*
 .XXX ±0.10
 UNIT mm

NO.	REV.	REVISIONS	CHK	DATE
△	A1	Modify Data	HZF	03/18/2020
△	A0	NEW RELEASE	HZF	10/07/2008