

Recommended P.C.B. Layout

△△ SPECIFICATION
 Current Rating:3A AC/DC
 Voltage Rating:250V AC Max.
 Withstanding Voltage:1000V AC/Minute
 Operation Temperature:-25°C~+85°C
 Contact Resistance:20 Milliohms Max.
 Insulation Resistance:1000 Megaohms Min.
 △ Contact:Brass,Tin Plated Over Nickel
 Insulator:PA66(UL94V-2)
 RoHS Compliant

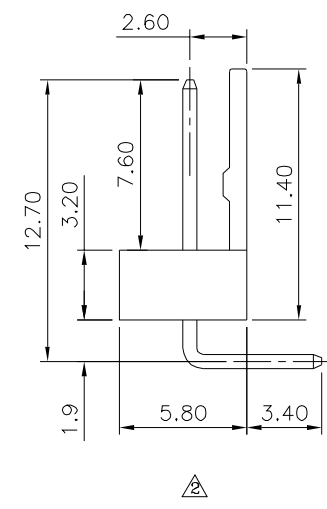
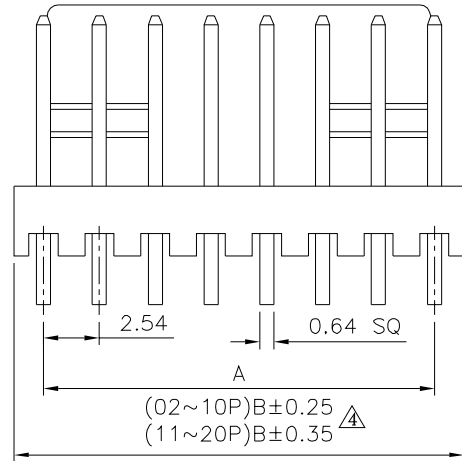
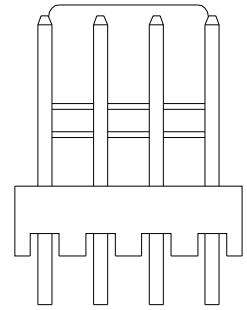
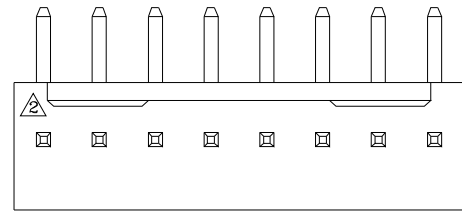
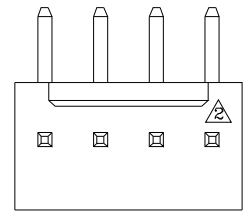

2~5 Pin

△6~20 Pin

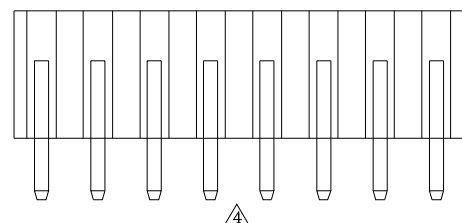

△ Pin	A	B
2	2.54	5.12
3	5.08	7.66
4	7.62	10.20
5	10.16	12.74
6	12.70	15.30
7	15.24	17.94
8	17.78	20.48
9	20.32	23.02
10	22.86	25.58
11	25.40	28.12
12	27.94	30.68
13	30.48	33.10
14	33.02	35.80
15	35.56	38.34
16	38.10	40.94
17	40.64	43.30
18	43.18	45.90
20	48.26	50.80

4UCON 元化興業股份有限公司
 4UCON TECHNOLOGY INC.

DRAWING No. △△
 01979

APPROVED BY MEI
 CHECKED BY HZF
 DRAWING BY CYP

UNLESS OTHERWISE SPECIFIED TOLERANCES ARE
 .X ±0.35
 .XX ±0.25
 ANG.

NO.	REV.	REVISIONS	CHK	DATE
△	A4	Modify Data	HZF	05/08/2015
△	A3	Modify Data	HZF	09/13/2012
△	A2	Modify Data	HZF	06/18/2010
△	A1	Modify Data	BECKY	2004/03/05
△	A0	NEW RELEASE		

SCALE NONE

REV. A4

UNIT mm

NO. REV. REVISIONS CHK DATE