

Material: P.P

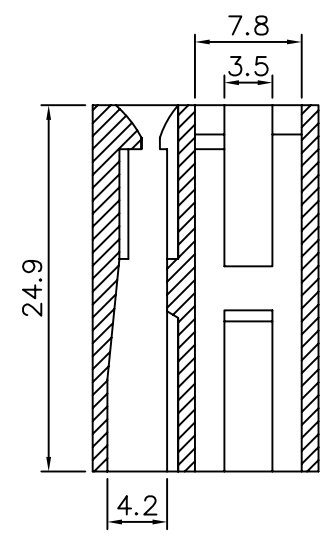
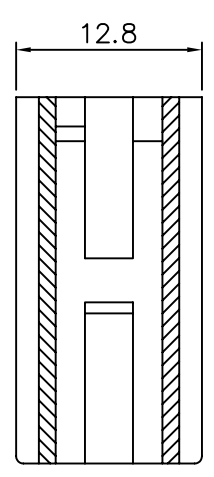
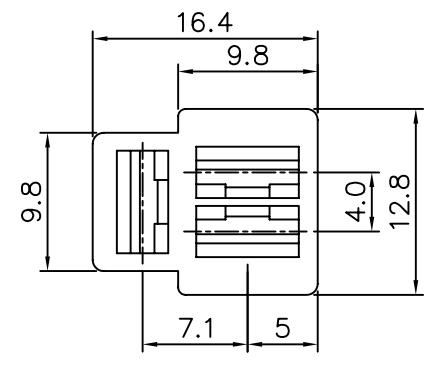

4UCON 元化興業股份有限公司
4UCON TECHNOLOGY INC.

DRAWING No.
02516

APPROVED BY MEI
CHECKED BY BECKY
DRAWING BY HZF

UNLESS OTHERWISE SPECIFIED
TOLERANCES ARE
0.1~5.0 ±0.10
5.01~10.0 ±0.20
10.01~20.0 ±0.30
20.01~30.0 ±0.35
30.01~50.0 ±0.40

SCALE NONE

REV. A1

UNIT mm

NO.	REV.	REVISIONS	CHK	DATE
1	A1	Modify Data	BECKY	2004/11/05
0	A0	NEW RELEASE	MEI	