

SPECIFICATIONS
 Material: Zinc Alloy, Ni Plated

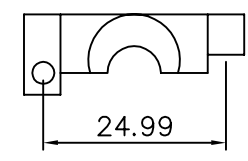
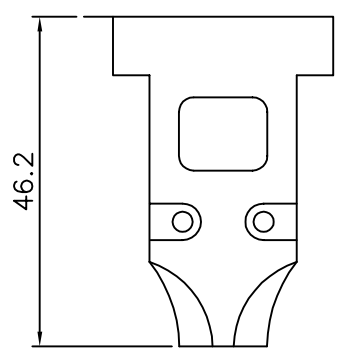
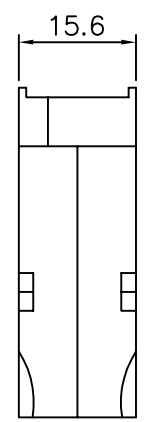
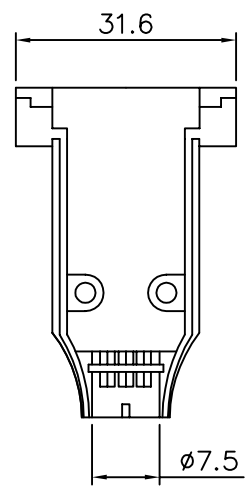

4UCON 元化興業股份有限公司
 4UCON TECHNOLOGY INC.

DRAWING No.		APPROVED BY		UNLESS OTHERWISE SPECIFIED TOLERANCES ARE
03007		MEI		
		RAN		
		DRAWING BY		.X ±0.38
		HZF		.XX ±0.25
		ANG.		
SCALE	NONE	REV.	A	UNIT
				mm

AREA	REVISIONS	CHK	DATE