

Recommended P.C.B. Layout(Top View)
(PCB Board Tolerance±0.05)

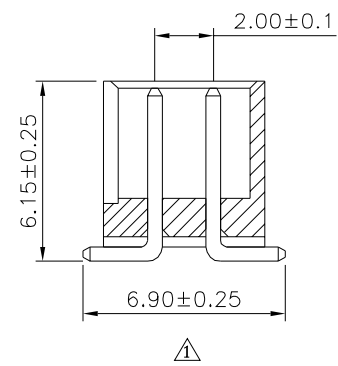
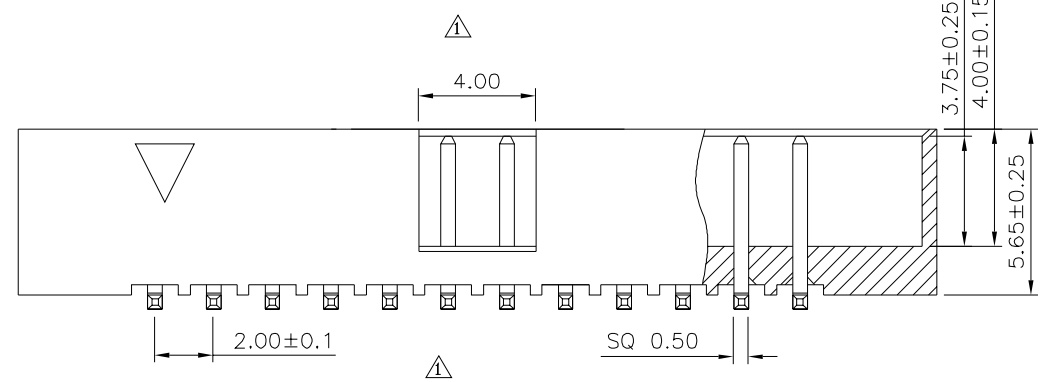
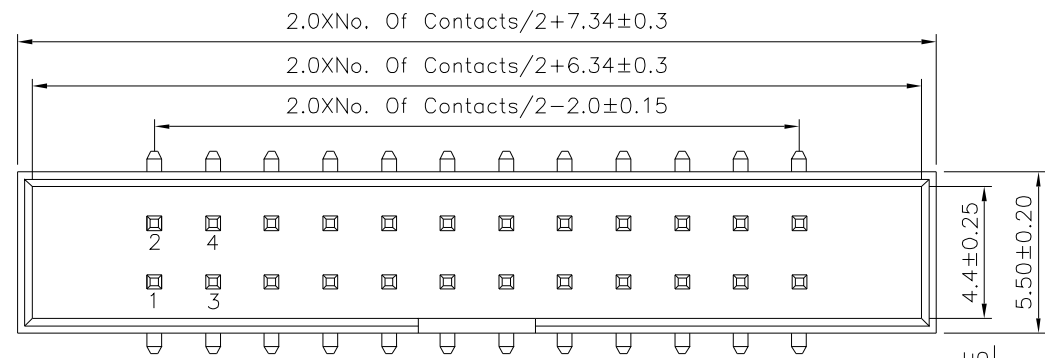

SPECIFICATION

Current Rating:1.5A
 Withstand Voltage:500V AC
 Contact Resistance:20 Milliohms Max.
 Insulation Resistance:1000 Megohms Min.
 Operation Temperature:-40°C~+105°C
 Housing:PA6T(UL94V-0),Black
 Contact:Brass,Gold Flash Over Nickel
 RoHS Compliant

4UCON 元化興業股份有限公司
 4UCON TECHNOLOGY INC.

DRAWING No.		APPROVED BY		UNLESS OTHERWISE SPECIFIED TOLERANCES ARE X. ±0.25 X.* ±2° .X ±0.20 .X* ±1.5° .XX ±0.15 .XX* ±1° .XXX ±0.10 .XXX* ±0.5°	
03505		MEI			
		CHECKED BY			
		HZF			
		DRAWING BY			
		CYP			
SCALE	NONE	REV.	A1	UNIT	mm

NO.	REV.	REVISIONS	CHK	DATE
△A1		Modify Data	HZF	05/23/2018
△A0		NEW RELEASE	HZF	12/06/2013