

SPECIFICATION
 Current Rating:3 Amp Max.
 Dielectric Withstanding Voltage:1000V AC RMS For 1 Minute
 Contact Resistance:30 Milliohms Max.
 Insulation Resistance:5000 Megaohms Min. At 1000V DC
 Operation Temperature:-55°C~+105°C
 Housing:PBT(UL94V-0),Gray
 Terminal:Brass,Selective Gold Plated Over Nickel
 RoHS Compliant

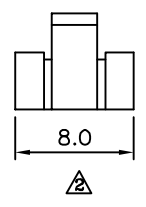
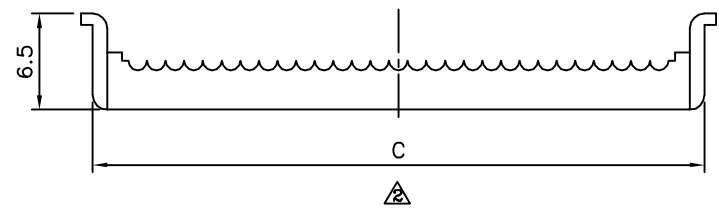
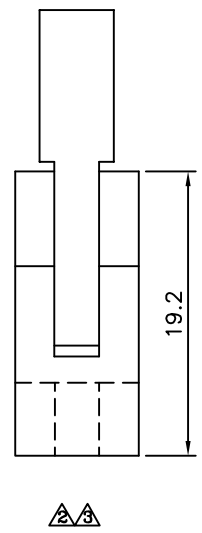
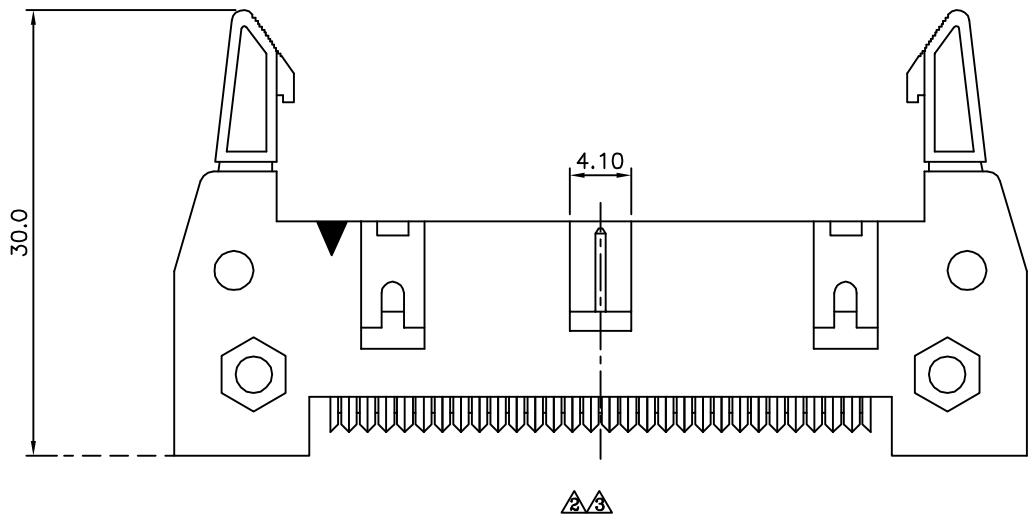

Pin	A±0.30	B	C±0.30
10	32.00	10.16	17.40
14	37.08	15.24	22.48
16	39.62	17.78	25.02
20	44.70	22.86	30.10
24	49.78	27.94	35.18
26	52.32	30.48	37.72
30	57.40	35.56	42.80
34	62.48	40.64	47.88
40	70.10	48.26	55.50
50	82.80	60.96	68.20
60	95.50	73.66	80.90
64	100.58	78.74	85.98

4UCON 元化興業股份有限公司
 4UCON TECHNOLOGY INC.

DRAWING No.		APPROVED BY		UNLESS OTHERWISE SPECIFIED TOLERANCES ARE .X ±0.30 .XX ±0.20 ANG.
03890		MEI		
		CHECKED BY		
		HZF		
		DRAWING BY		UNIT mm
		SONG		
SCALE	NONE	REV.	A3	NO. REV.

△ A3	Modify Data	HZF	06/11/2013
△ A2	Modify Data	HZF	05/18/2010
△ A1	Modify Data	BECKY	2005/01/10
△ A0	NEW RELEASE		
CHK	DATE		