

Recommended P.C.B. Layout

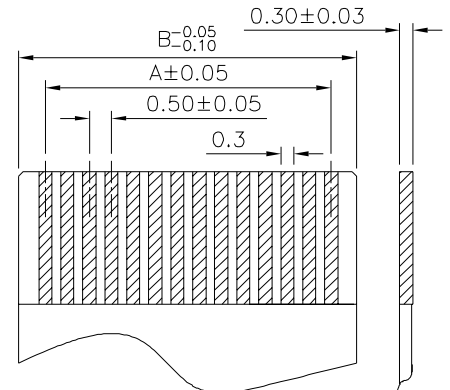

Accommodated FFC/FPC

△ SPECIFICATION

1. Material & Finish  
 ① Insulator: LCP(UL94V-0), Nature  
 ② Terminal: Phosphor Bronze, Tin Plated  
 ③ Slider: LCP(UL94V-0), Black  
 ④ Latch: Brass, Tin Plated
2. Electrical Characteristics  
 Voltage Rating: 50V AC/DC  
 Contact Resistance: 30 Milliohms Max.  
 Insulation Resistance: 500 Megaohms Min.
3. Environmental Characteristics  
 Temperature Range: -25°C ~ +85°C
4. RoHS Compliant

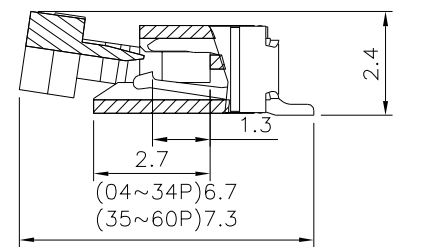
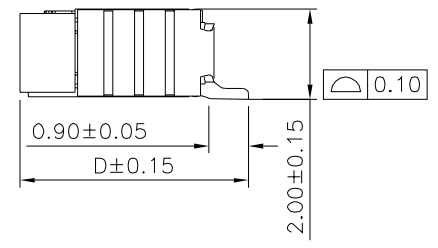
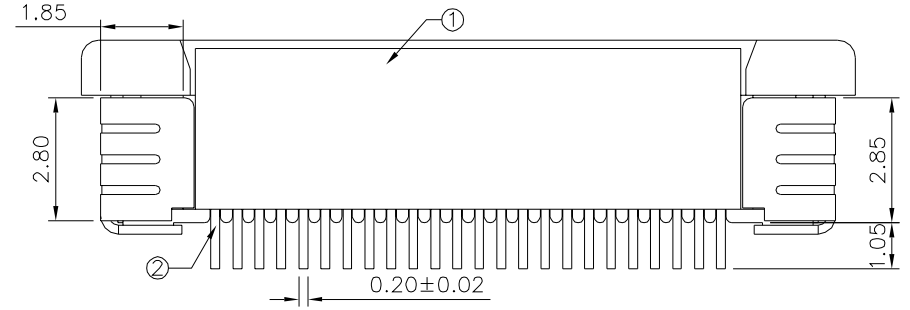
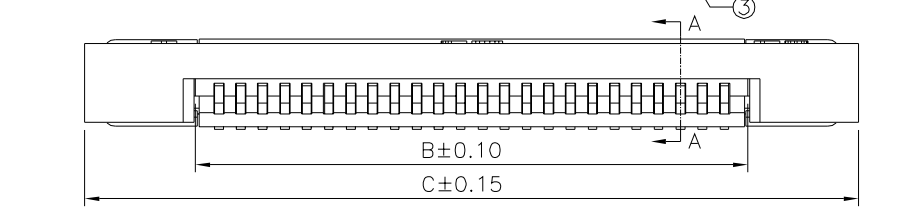
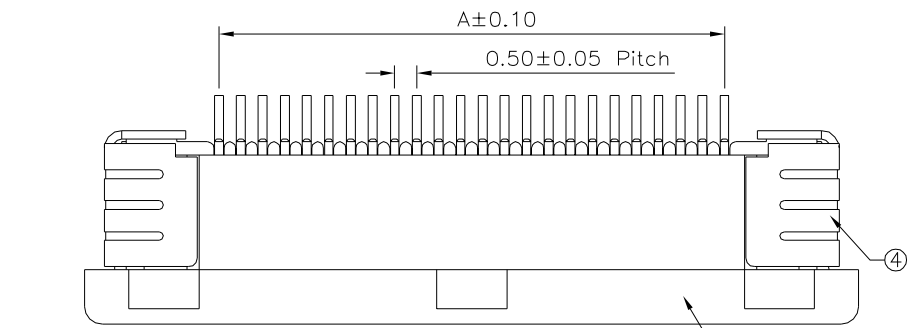
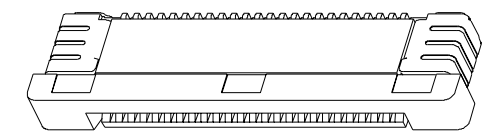

Section A-A

Pin	A	B	C	D	Pin	A	B	C	D
*4	1.50	2.56	7.60	5.20	33	16.00	17.06	22.10	5.20
*5	2.00	3.06	8.10		*34	16.50	17.56	22.60	
*6	2.50	3.56	8.60		35	17.00	18.06	23.10	
*7	3.00	4.06	9.10		*36	17.50	18.56	23.60	
*8	3.50	4.56	9.60		37	18.00	19.06	24.10	
*9	4.00	5.06	10.10		38	18.50	19.56	24.60	
*10	4.50	5.56	10.60		39	19.00	20.06		
*11	5.00	6.06	11.10		*40	19.50	20.56		
*12	5.50	6.56	11.60		41	20.00	21.06		
*13	6.00	7.06	12.10		*42	20.50	21.56		
*14	6.50	7.56	12.60		43	21.00	22.06		
*15	7.00	8.06	13.10		44	21.50	22.56		
*16	7.50	8.56	13.60		*45	22.00	23.06		
17	8.00	9.06	14.10		46	22.50	23.56		
*18	8.50	9.56	14.60		47	23.00	24.06	5.75	
19	9.00	10.06	15.10		48	23.50	24.56		
*20	9.50	10.56	15.60		49	24.00	25.06		
21	10.00	11.06	16.10		*50	24.50	25.56		
*22	10.50	11.56	16.60		51	25.00	26.06		
23	11.00	12.06	17.10		52	25.50	26.56		
*24	11.50	12.56	17.60		53	26.00	27.06		
25	12.00	13.06	18.10		*54	26.50	27.56		
*26	12.50	13.56	18.60		55	27.00	28.06		
27	13.00	14.06	19.10		56	27.50	28.56		
*28	13.50	14.56	19.60		57	28.00	29.06		
29	14.00	15.06	20.10		58	28.50	29.56		
*30	14.50	15.56	20.60		59	29.00	30.06		
*31	15.00	16.06	21.10		*60	29.50	30.56		
*32	15.50	16.56	21.60						

The Mark Of "\*" Are Tooled

**4UCON** 元化興業股份有限公司  
 4UCON TECHNOLOGY INC.

DRAWING No. 03977

APPROVED BY MEI  
 CHECKED BY HZF  
 DRAWING BY CYP

UNLESS OTHERWISE SPECIFIED TOLERANCES ARE  
 X ±0.50  
 XX ±0.20  
 XXX ±0.10  
 .XXX ±0.05  
 ANG. ±1°

SCALE NONE REV. A1 UNIT mm

△ A1	Modify Data	HZF	07/19/2021
△ A0	NEW RELEASE	HZF	10/11/2015
NO. REV.	REVISIONS	CHK	DATE