

**3.2.1 SPECIFICATION**

- 1.General Characteristics  
0.8mm FPC XXP SMT 90° ZIF Upper Contact
- 2.Material&Finish  
Latch:PA46(UL94V-0),Black  
Housing:LCP(UL94V-0),Nature  
Contact:Phosphor Bronze,Tin Plated Over Nickel
- 3.Electrical Characteristics  
Current Rating:0.5 Amp AC/DC  
Voltage Rating:50V AC/DC  
Contact Resistance:20 Milliohms Max.  
Insulation Resistance:500 Megohms Min. @500V DC
- 4.Environmental Characteristics  
Operation Temperature:-40°C~+105°C
- 5.RoHS Compliant

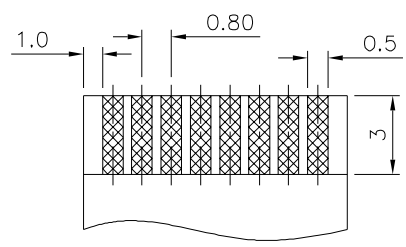

FPC/FPC Dimension  
Thickness:0.300  $\pm$ 0.05 / -0.03 mm

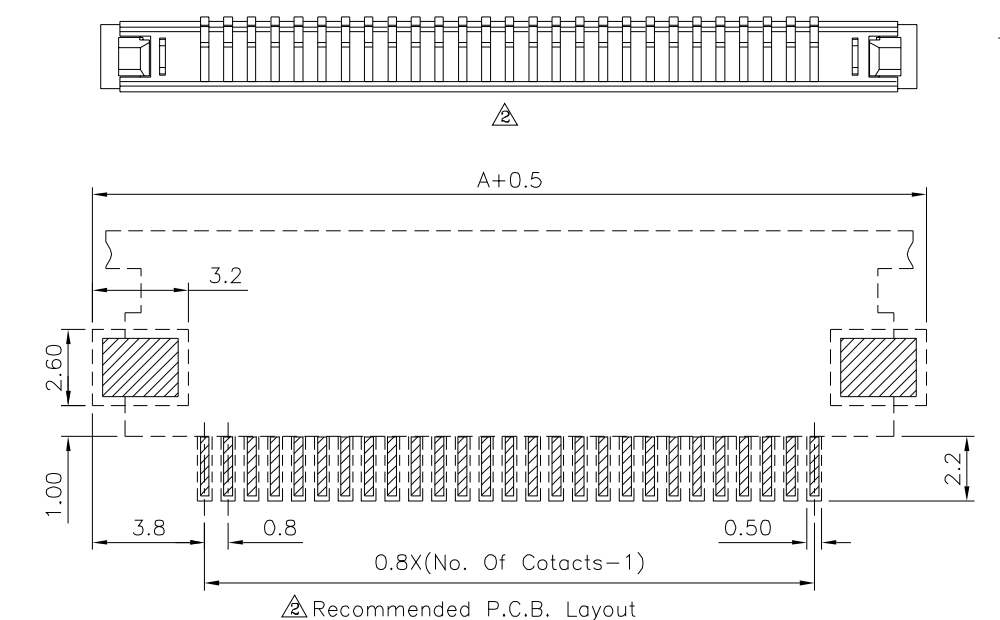
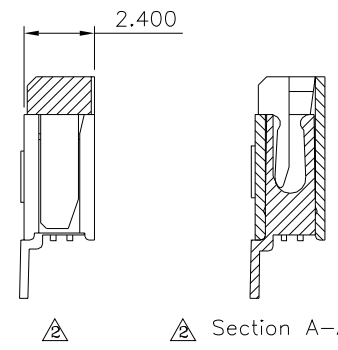
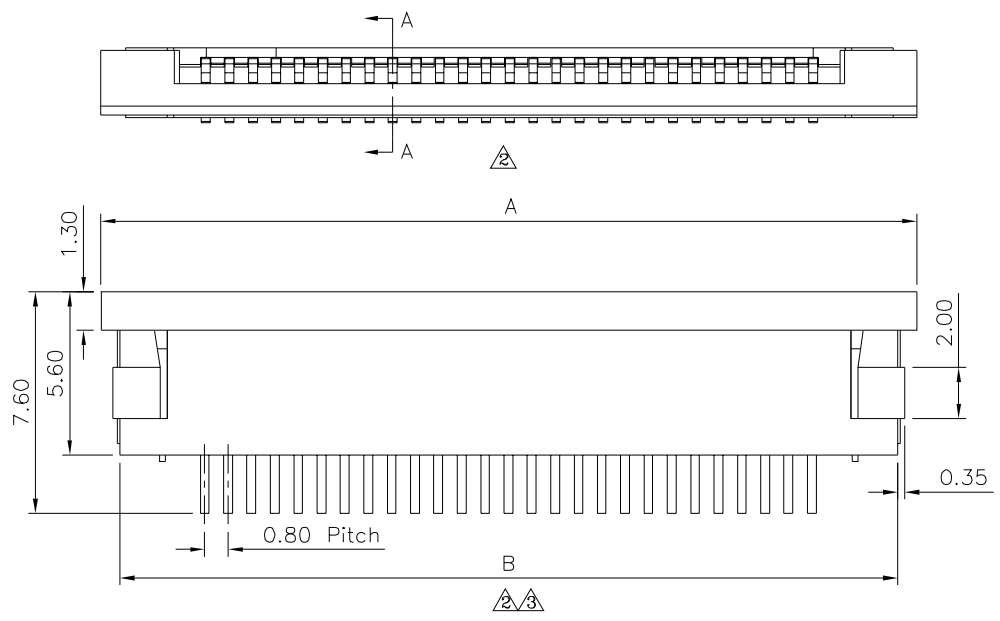
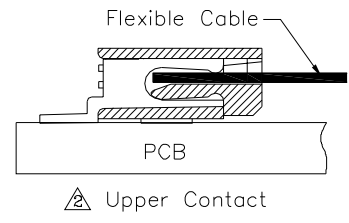

Pin	A	B	Pin	A	B
04	9.50	8.20	19	21.50	20.20
05	10.30	9.00	20	22.30	21.00
06	11.10	9.80	*21	23.10	21.80
07	11.90	10.60	*22	23.90	22.60
*08	12.70	11.40	*23	24.70	23.40
*09	13.50	12.20	24	25.50	24.20
*10	14.30	13.00	*25	26.30	25.00
11	15.10	13.80	*26	27.10	25.80
*12	15.90	14.60	*27	27.90	26.60
13	16.70	15.40	*28	28.70	27.40
*14	17.50	16.20	29	29.50	28.20
15	18.30	17.00	*30	30.30	29.00
16	19.10	17.80	31	31.10	29.80
17	19.90	18.60	32	31.90	30.60
*18	20.70	19.40			

The Mark Of "\*" Are Tooled Already

**4UCON** 元化興業股份有限公司  
4UCON TECHNOLOGY INC.

DRAWING No.		APPROVED BY		UNLESS OTHERWISE SPECIFIED TOLERANCES ARE .X $\pm$ 0.25 .XX $\pm$ 0.20 .XXX $\pm$ 0.10 ANG. $\pm$ 2°
04027		EMILY		
		CHECKED BY		
		HZF		
		DRAWING BY		UNIT mm
		HAO		
SCALE	NONE	REV.	B3	

NO.	REV.	REVISIONS	CHK	DATE
3	B3	Modify Data	HZF	05/05/2015
2	B2	Modify Data	HZF	03/06/2013
1	B1	Modify Data	HZF	07/29/2011
0	B0	NEW RELEASE	HZF	05/16/2009