

△ SPECIFICATION
 Current Rating: 3 Amp
 Withstand Voltage: 500V For 1 Minute
 Contact Resistance: 20 Milliohms Max.
 Insulation Resistance: 5000 Megaohms Min.
 At 500V DC
 Temperature Range: -40°C ~ +105°C
 Insulator: PBT+30%G.F.(UL94V-0)
 Contact: Brass, Gold Plated Over Nickel
 RoHS Compliant

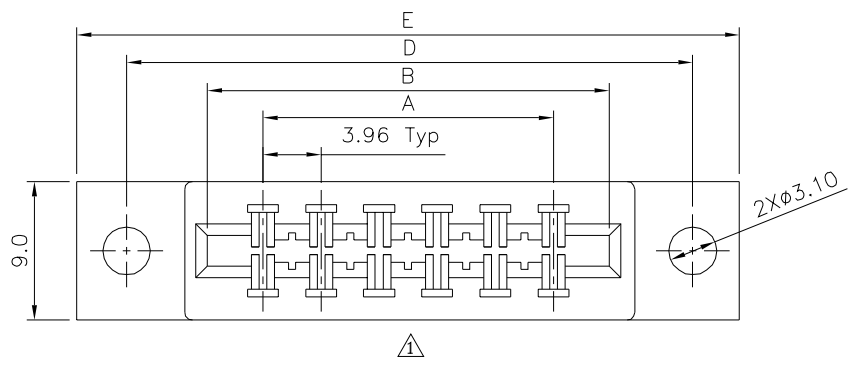

△ △ Daughter Card Layout

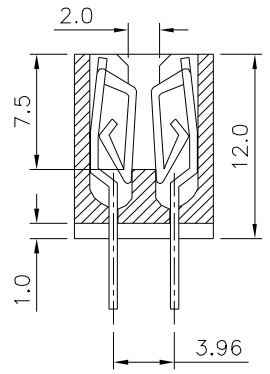
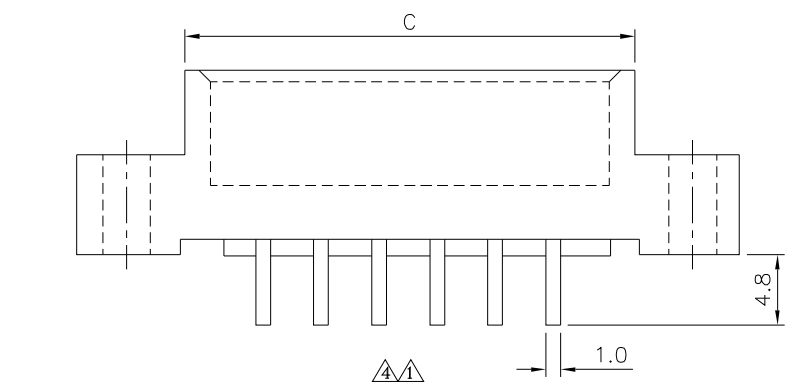

△ △

Pin	A	B	C	D	E
*10	15.84	24.06	27.40	34.94	41.24
*12	19.80	28.02	31.36	38.90	45.20
*16	27.72	35.94	39.28	46.82	53.12
*20	35.64	43.86	47.20	54.74	61.04
22	39.60	47.82	51.16	58.70	65.00
*24	43.56	51.78	55.12	62.66	68.96
28	51.48	59.70	63.04	70.58	76.88
*30	55.44	63.66	67.00	74.54	80.84
32	59.40	67.62	70.96	78.50	84.80
*36	67.32	75.54	78.88	86.42	92.72
*40	75.24	83.46	86.80	94.34	100.64
*44	83.16	91.38	94.72	102.26	108.56
46	87.12	95.34	98.68	106.22	112.52
*48	91.08	99.30	102.64	110.18	116.48
*50	95.04	103.26	106.60	114.14	120.44
*56	106.92	115.14	118.48	126.02	132.32
*60	114.84	123.06	126.40	133.94	140.24
*62	118.80	127.02	130.36	137.90	144.20
64	122.76	130.98	134.32	141.86	148.16
70	134.64	142.86	146.20	153.74	160.04
*72	138.60	146.82	150.16	157.70	164.00
*86	166.32	174.54	177.88	185.49	191.48

△ The Mark Of "*" Are Toolled Already

4UCON 元化興業股份有限公司
 4UCON TECHNOLOGY INC.

DRAWING No. △ 04652
 APPROVED BY MEI
 CHECKED BY HZF
 DRAWING BY CYP
 SCALE NONE REV. A4

UNLESS OTHERWISE SPECIFIED TOLERANCES ARE
 0~10 ±0.2 100~300 ±0.5
 10~30 ±0.3 300~ ±0.6
 30~100 ±0.4 △ ANG. ±0.5
 UNIT mm

NO.	REV.	REVISIONS	CHK	DATE
△4	A4	Modify Data	HZF	04/12/2019
△3	A3	Modify Data	HZF	11/22/2017
△2	A2	Modify Data	HZF	08/16/2013
△1	A1	Modify Data	HZF	10/20/2010
△0	A0	NEW RELEASE	BECKY	03/27/2006