

SPECIFICATIONS:
 Insulator : Polycarbonate,UL 94V-2
 Contact: Copper Alloy,Gold Flash 30u"

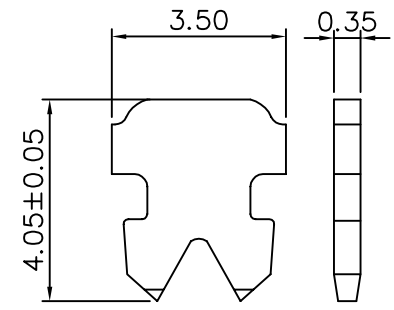

2 Prongs For Stranded Wire

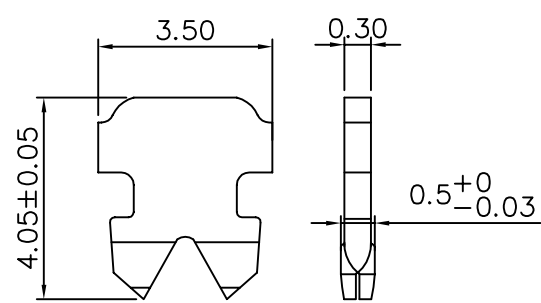
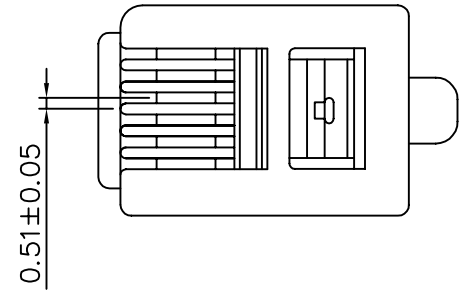

2 Prongs For Solid Wire

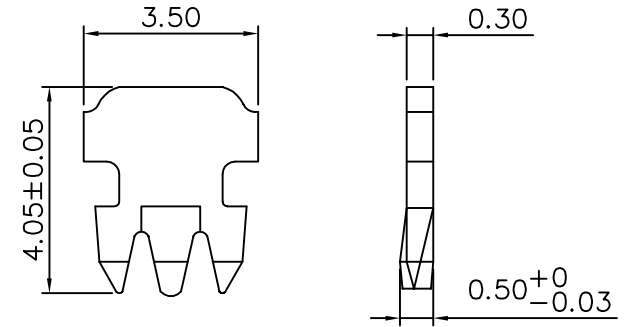

3 Prongs For Solid Wire

4UCON 元化興業股份有限公司
 4UCON TECHNOLOGY INC.

DRAWING No.
 04844

APPROVED BY MEI
 CHECKED BY RAN
 DRAWING BY HZF

UNLESS OTHERWISE SPECIFIED
 TOLERANCES ARE
 .X ±0.38
 .XX ±0.25
 AWG.

SCALE NONE

REV. A

UNIT mm

AREA REVISIONS CHK DATE