

PC Board Layout

SPECIFICATION:
 Housing : PBT Polyester UL 94V-0
 Contacts : 0.46mm Diameter Phosphor Bronze , Gold Plated 6u"

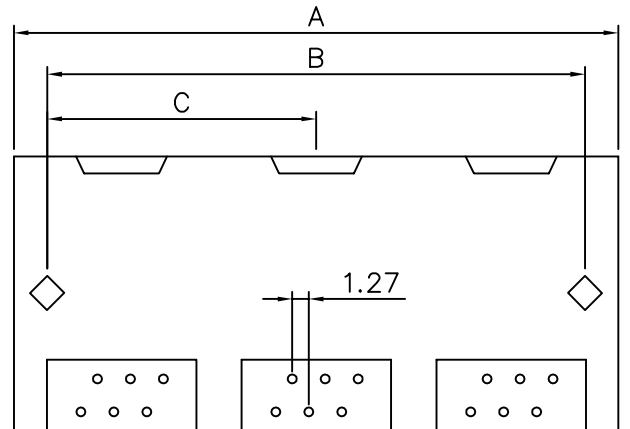
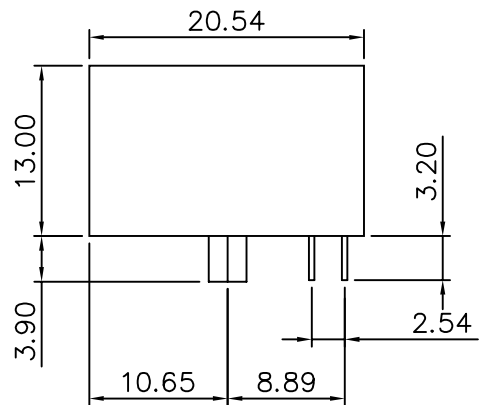
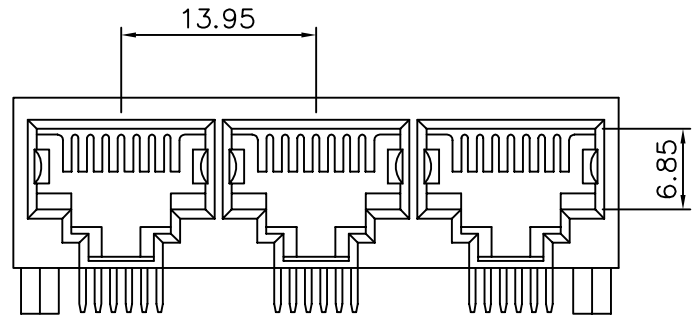

Dimension	No.Of Jack											
	2	3	4	5	6	7	8	9	10	11	12	
A	30.48	44.45	58.42	72.39	86.36	110.33	114.30	128.27	142.24	156.21	170.18	
B	25.40	39.37	53.34	67.31	81.28	95.25	109.22	123.19	137.16	151.13	165.10	
C	12.70	19.69	26.67	33.66	40.64	47.63	54.61	61.60	68.58	75.57	82.56	

4UCON 元化興業股份有限公司
 4UCON TECHNOLOGY INC.

DRAWING No.
 04949

APPROVED BY
 MEI
 CHECKED BY
 RAN
 DRAWING BY
 HZF

UNLESS OTHERWISE SPECIFIED
 TOLERANCES ARE
 .X ±0.38
 .XX ±0.25
 .XXX

SCALE NONE REV. A UNIT mm

AREA	REVISIONS	CHK	DATE